

FIXED WINDOW 3-6

PROJECT-IN WINDOW 7-10

PROJECT-OUT WINDOW 11-16

INSWING CASEMENT WINDOW 17-22

OUTSWING CASEMENT WINDOW 23-28

MULLIONS 29-31

RECEPTORS AND SUB SILLS 32

ANCHORING 33

LAWS AND BUILDING AND SAFETY CODES GOVERNING THE DESIGN AND USE OF GLAZED ENTRANCE, WINDOW, AND CURTAIN WALL PRODUCTS VARY WIDELY. KAWNEER DOES NOT CONTROL THE SELECTION OF PRODUCT CONFIGURATIONS, OPERATING HARDWARE, OR GLAZING MATERIALS, AND ASSUMES NO RESPONSIBILITY THEREFOR.

Metric (SI) conversion figures are included throughout these details for reference. Numbers in parentheses () are millimeters unless otherwise noted.

The following metric (SI) units are found in these details:

- m – meter
- cm – centimeter
- mm – millimeter
- s – second
- Pa – pascal
- MPa – megapascal

Kawneer reserves the right to change configurations without prior notice when deemed necessary for product improvement.

Laws and building and safety codes governing the design and use of glazed entrance, window, and curtain wall products vary widely. Kawneer does not control the selection of product configurations, operating hardware, or glazing materials, and assumes no responsibility therefor.

Kawneer reserves the right to change configuration without prior notice when deemed necessary for product improvement.
© Kawneer Company, Inc., 2011

Laws and building and safety codes governing the design and use of glazed entrance, window, and curtain wall products vary widely. Kawneer does not control the selection of product configurations, operating hardware, or glazing materials, and assumes no responsibility therefor.

Kawneer reserves the right to change configuration without prior notice when deemed necessary for product improvement.
© Kawneer Company, Inc., 2011

Features

- Architectural Grade Window
- Non-Thermally Broken Frames
- Screw and Spline Frame Corner Joinery
- Factory Silicone Glazed
- Interior Applied Glazing Bead with Bulb Gasket
- Architectural Anodized Finishes and Applied Coatings
- Two Year Manufacturer's Warranty

Laws and building and safety codes governing the design, and use of glazed entrance, window, and curtain wall products vary widely. Kawneer does not control the selection of product configurations, operating hardware, or glazing materials, and assumes no responsibility therefor.

Kawneer reserves the right to change configuration without prior notice when deemed necessary for product improvement.
© Kawneer Company, Inc., 2011

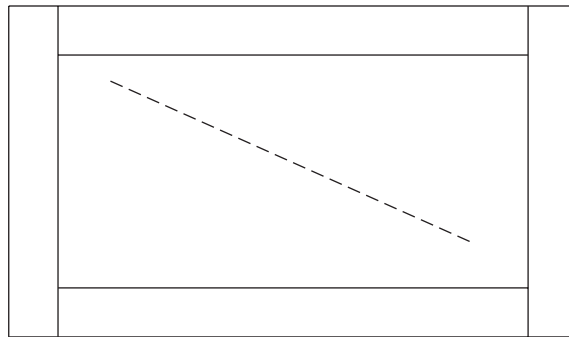

Fixed Window



Exterior

Interior

For specific product applications,
Consult your Kawneer representative.

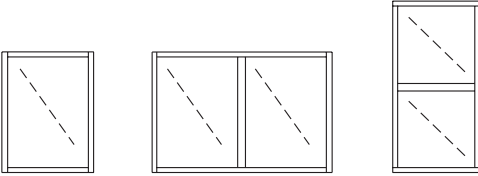
CLASS and GRADE		Architectural Grade AW-PG100-FW				
TESTING STANDARD		AAMA / WDMA / CSA 101 / I.S. 2 / A440 (NAFS)				
FRAME DEPTH		2-1/4" Overall Frame Depth				
TYPICAL WALL THICKNESS		.090 and .125 Nominal				
TYPICAL MAXIMUM SIZE		60" x 99"				
TYPICAL MINIMUM SIZE		12" x 12"				
TYPICAL CONFIGURATIONS						
STANDARD INFILL OPTIONS		1/4" and 1"				
STANDARD HARDWARE		Not Applicable				
OPTIONAL HARDWARE		Not Applicable				
OTHER OPTIONS		Unequal Leg Frames Exterior and/or Interior Applied Muntins Perimeters and Sills Exterior Pannings and Interior Trims Structural Mullions Vertically or Horizontally Stacked Access Panels and Blinds Silicone Field Glazed upon Request				
PERFORMANCE	Air Infiltration Cfm/ft ²	Water Resistance PSF	Design Load PSF	Thermal Transmittance "U" Value	Condensation Resistance CRF	Sound Transmittance STC
	.10 @ 6.24 psf	15	100	n/a	n/a	n/a

Laws and building and safety codes governing the design and use of glazed entrance, window, and curtain wall products vary widely. Kawneer does not control the selection of product configurations, operating hardware, or glazing materials, and assumes no responsibility therefor.

Kawneer reserves the right to change configuration without prior notice when deemed necessary for product improvement.
© Kawneer Company, Inc., 2011

SCALE : 3" = 1'-0"

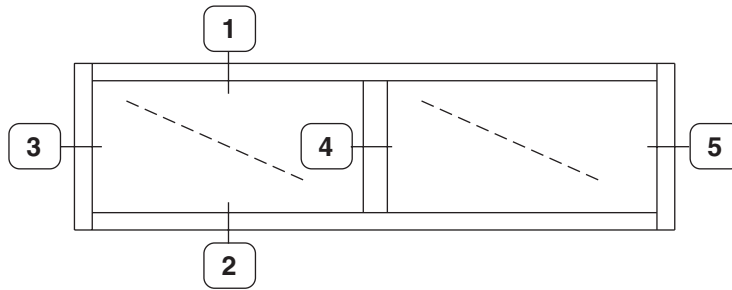

TYPICAL ELEVATION

Log onto www.kawneer.com for other configurations

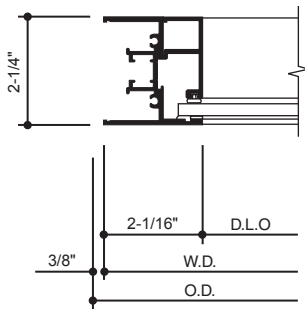
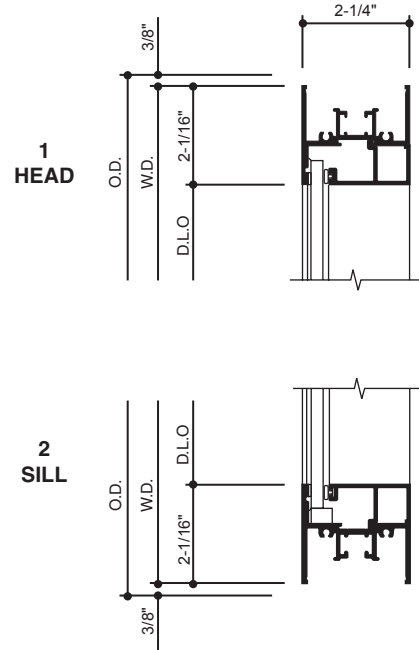

3 JAMB

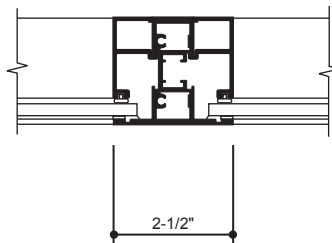

4 VERTICAL MULLION

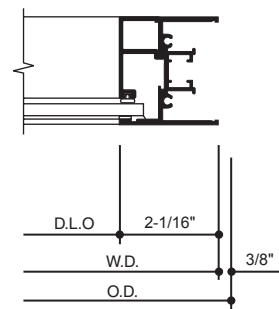

5 JAMB

Laws and building and safety codes governing the design, and use of glazed entrance, window, and curtain wall products vary widely. Kawneer does not control the selection of product configurations, operating hardware, or glazing materials, and assumes no responsibility therefor.

Kawneer reserves the right to change configuration without prior notice when deemed necessary for product improvement.
© Kawneer Company, Inc., 2011

Laws and building and safety codes governing the design and use of glazed entrance, window, and curtain wall products vary widely. Kawneer does not control the selection of product configurations, operating hardware, or glazing materials, and assumes no responsibility therefor.

Kawneer reserves the right to change configuration without prior notice when deemed necessary for product improvement.
© Kawneer Company, Inc., 2011

Features

- Architectural Grade Window
- Non-Thermally Broken Frames
- Mitered, Clipped and Staked Vent Corner Joinery
- Screw and Spline Frame Corner Joinery
- Factory Silicone Glazed
- Interior Applied Glazing Bead with Bulb Gasket
- Architectural Anodized Finishes and Applied Coatings
- Two Year Manufacturer's Warranty
- Compatible with Storefront and Curtain Wall Systems

Laws and building and safety codes governing the design, and use of glazed entrance, window, and curtain wall products vary widely. Kawneer does not control the selection of product configurations, operating hardware, or glazing materials, and assumes no responsibility therefor.

Kawneer reserves the right to change configuration without prior notice when deemed necessary for product improvement.
© Kawneer Company, Inc., 2011

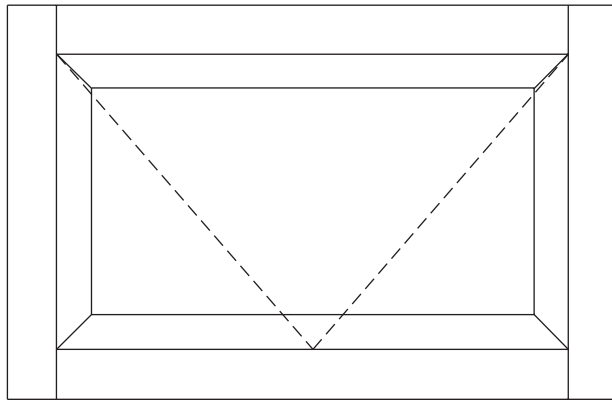

Project-In Window

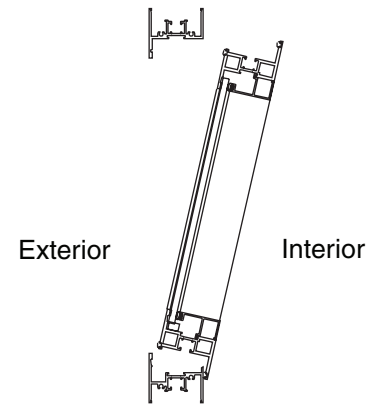

For specific product applications,
Consult your Kawneer representative.

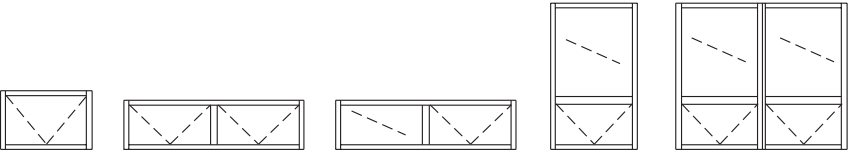
CLASS and GRADE		Architectural Grade AP-HC90 / AP-AW90 / AP-PG90-AP				
TESTING STANDARD		AAMA / WDMA / CSA 101 / I.S. 2 / A440 (NAFS)				
FRAME DEPTH		2-1/4" Overall Frame Depth				
TYPICAL WALL THICKNESS		.090 and .125 Nominal				
TYPICAL MAXIMUM SIZE		60" x 48"				
TYPICAL MINIMUM SIZE		17" x 17"				
TYPICAL CONFIGURATIONS						
STANDARD INFILL OPTIONS		1/4" and 1"				
STANDARD HARDWARE		Stainless Steel 4-Bar Hinges Cast White Bronze Cam Locks				
OPTIONAL HARDWARE		Access Control Locks Limit Stop Pole and Pole Ring				
OTHER OPTIONS		Unequal Leg Frames Exterior and/or Interior Applied Muntins Insect Screens Perimeters and Sills Exterior Pannings and Interior Trims Structural Mullions Vertically or Horizontally Stacked Access Panels and Blinds Silicone Field Glazed upon Request				
PERFORMANCE	Air Infiltration Cfm/ft ²	Water Resistance PSF	Design Load PSF	Thermal Transmittance "U" Value	Condensation Resistance CRF	Sound Transmittance STC
	.10 @ 6.24 psf	15	90	n/a	n/a	n/a

Laws and building and safety codes governing the design and use of glazed entrance, window, and curtain wall products vary widely. Kawneer does not control the selection of product configurations, operating hardware, or glazing materials, and assumes no responsibility therefor.

Kawneer reserves the right to change configuration without prior notice when deemed necessary for product improvement.
© Kawneer Company, Inc., 2011

SCALE : 3" = 1'-0"

Laws and building and safety codes governing the design and use of glazed entrance, window, and curtain wall products vary widely. Kawneer does not control the selection of product configurations, operating hardware, or glazing materials, and assumes no responsibility therefor.

Kawneer reserves the right to change configuration without prior notice when deemed necessary for product improvement.
© Kawneer Company, Inc., 2011

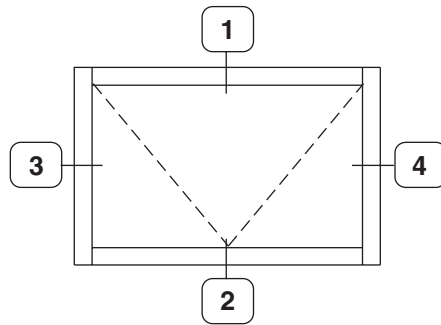

TYPICAL ELEVATION

Log onto www.kawneer.com for other configurations

1 HEAD

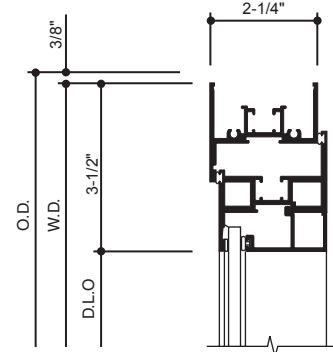

2 SILL

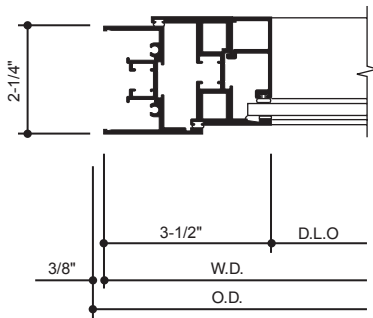
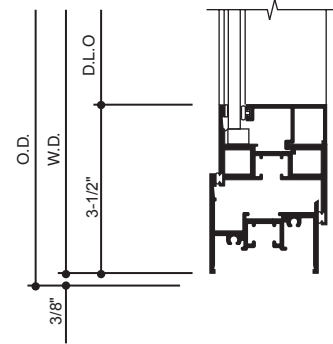

3 JAMB

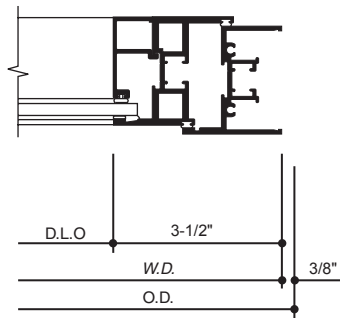

4 JAMB

STAINLESS STEEL 4 BAR HINGES

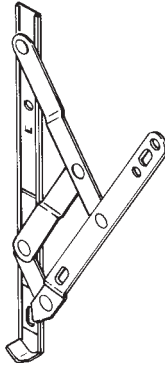

A standard hinge for ventilators providing approximately 45° to 60° openings depending on size. An optional limit stop is available to restrict hinge travel and limit vent opening.

STANDARD CAM HANDLE



Cast white bronze cam handles are standard for the manual operation and locking of ventilators.

CAM HANDLE WITH POLE RING

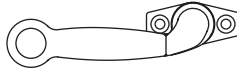

Cast white bronze cam handles with pole ring provide manual operation of ventilators located above reach. These handles are operated with a sash pole.

POLE RING



Cast white bronze pole ring is used in conjunction with locking hardware for sash pole operation of ventilators.

SASH POLE

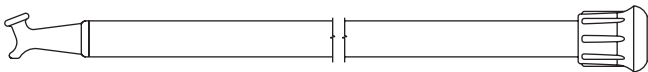

HANGER FOR SASH POLE



A 3/4" diameter aluminum sash pole with a cast white bronze pull down hook and black rubber tip. Available in 6 ft. and 12 ft. lengths with optional cast white bronze pole hanger.

ACCESS CONTROL LOCK

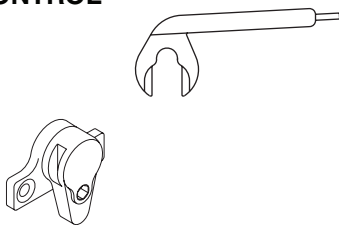

In lieu of the standard cam handles cast white bronze access control locks are offered for managed control of vent operations. Lock is operated with a manganese bronze removable handle.

Laws and building and safety codes governing the design and use of glazed entrance, window, and curtain wall products vary widely. Kawneer does not control the selection of product configurations, operating hardware, or glazing materials, and assumes no responsibility therefor.

Kawneer reserves the right to change configuration without prior notice when deemed necessary for product improvement.
© Kawneer Company, Inc., 2011

Features

- Architectural Grade Window
- Non-Thermally Broken Frames
- Mitered, Clipped and Staked Vent Corner Joinery
- Screw and Spline Frame Corner Joinery
- Factory Silicone Glazed
- Interior Applied Glazing Bead with Bulb Gasket
- Architectural Anodized Finishes and Applied Coatings
- Two Year Manufacturer's Warranty
- Compatible with Storefront and Curtain Wall Systems

Laws and building and safety codes governing the design and use of glazed entrance, window, and curtain wall products vary widely. Kawneer does not control the selection of product configurations, operating hardware, or glazing materials, and assumes no responsibility therefor.

Kawneer reserves the right to change configuration without prior notice when deemed necessary for product improvement.
© Kawneer Company, Inc., 2011

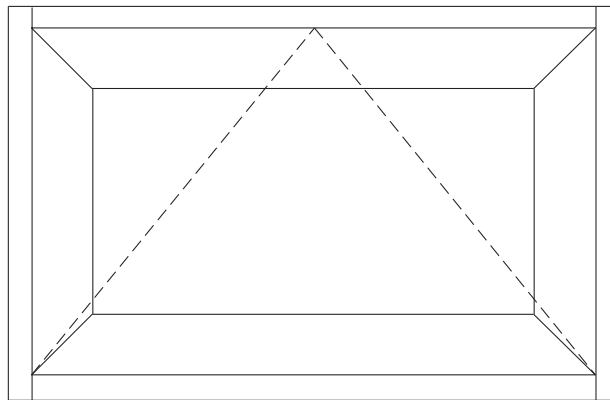

Project-Out Window

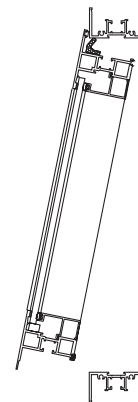

Exterior

Interior

For specific product applications,
Consult your Kawneer representative.

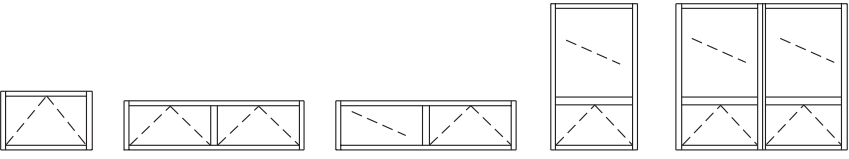
CLASS and GRADE		Architectural Grade AP-HC90 / AP-AW90 / AW-PG90-AP				
TESTING STANDARD		AAMA / WDMA / CSA 101 / I.S. 2 / A440 (NAFS)				
FRAME DEPTH		2-1/4" Overall Frame Depth				
TYPICAL WALL THICKNESS		.090 and .125 Nominal				
TYPICAL MAXIMUM SIZE		60" x 89"				
TYPICAL MINIMUM SIZE		17" x 17"				
TYPICAL CONFIGURATIONS						
STANDARD INFILL OPTIONS		1/4" and 1"				
STANDARD HARDWARE		Stainless Steel 4-Bar Hinges Cast White Bronze Cam Locks 88SS Support Arm (Units over 50" in height)				
OPTIONAL HARDWARE		Access Control Locks Hook Bolt Lock Handle Pivot Shoe Roto-Operator Scissors Arm Roto-Operator Limit Stop Pole and Pole Ring				
OTHER OPTIONS		Unequal Leg Frames Exterior and/or Interior Applied Muntins Insect Screens Perimeters and Sills Exterior Pannings and Interior Trims Structural Mullions Vertically or Horizontally Stacked Access Panels and Blinds Silicone Field Glazed upon Request				
PERFORMANCE	Air Infiltration Cfm/ft ²	Water Resistance PSF	Design Load PSF	Thermal Transmittance "U" Value	Condensation Resistance CRF	Sound Transmittance STC
	.10 @ 6.24 psf	15	90	n/a	n/a	n/a

Laws and building and safety codes governing the design and use of glazed entrance, window, and curtain wall products vary widely. Kawneer does not control the selection of product configurations, operating hardware, or glazing materials, and assumes no responsibility therefor.

Kawneer reserves the right to change configuration without prior notice when deemed necessary for product improvement.
© Kawneer Company, Inc., 2011

SCALE : 3" = 1'-0"

Laws and building and safety codes governing the design and use of glazed entrance, window, and curtain wall products vary widely. Kawneer does not control the selection of product configurations, operating hardware, or glazing materials, and assumes no responsibility therefor.

Kawneer reserves the right to change configuration without prior notice when deemed necessary for product improvement.
© Kawneer Company, Inc., 2011

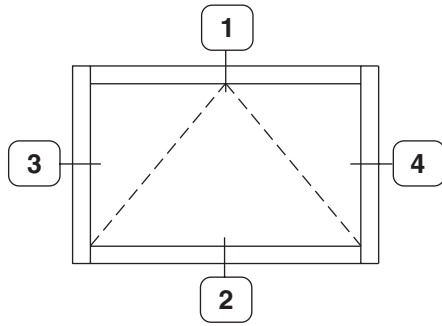

TYPICAL ELEVATION

Log onto www.kawneer.com for other configurations

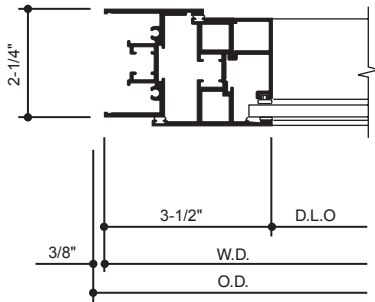
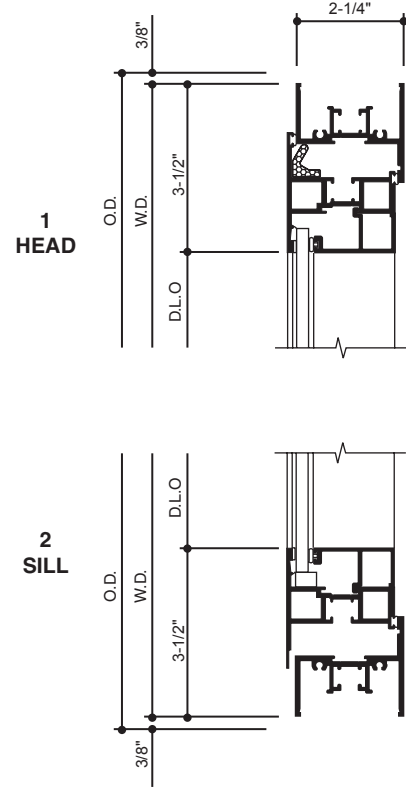

**3
JAMB**

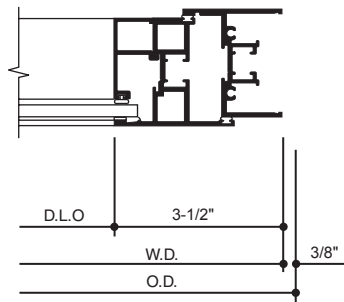

**4
JAMB**

STAINLESS STEEL 4 BAR HINGES

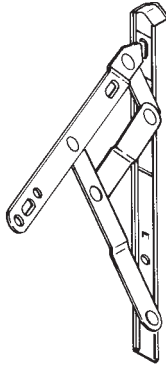

A standard hinge for ventilators providing approximately 45° to 60° openings depending on size. An optional limit stop is available to restrict hinge travel and limit vent opening.

STANDARD CAM HANDLE

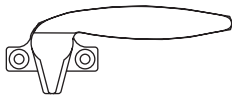

Cast white bronze cam handles are standard for the manual operation and locking of ventilators.

CAM HANDLE WITH POLE RING

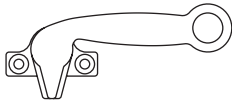

Cast white bronze cam handles with pole ring provide manual operation of ventilators located above reach. These handles are operated with a sash pole.

POLE RING



Cast white bronze pole ring is used in conjunction with locking hardware for sash pole operation of ventilators.

SASH POLE

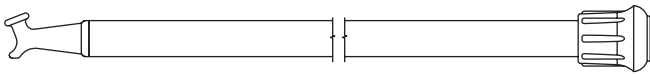

HANGER FOR SASH POLE



A 3/4" diameter aluminum sash pole with a cast white bronze pull down hook and black rubber tip. Available in 6 ft. and 12 ft. lengths with optional cast white bronze pole hanger.

ACCESS CONTROL LOCK

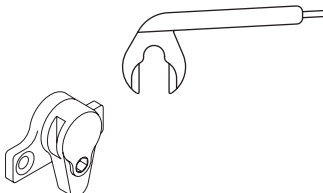

In lieu of the standard cam handles cast white bronze access control locks are offered for managed control of vent operations. Lock is operated with a manganese bronze removable handle.

Laws and building and safety codes governing the design and use of glazed entrance, window, and curtain wall products vary widely. Kawneer does not control the selection of product configurations, operating hardware, or glazing materials, and assumes no responsibility therefor.

Kawneer reserves the right to change configuration without prior notice when deemed necessary for product improvement.
© Kawneer Company, Inc., 2011

**PIVOT-SHOE
ROTO-OPERATOR**

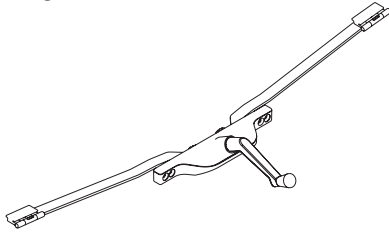

Optional pivot shoe roto operator is located on the center line of the bottom horizontal frame.
Standard finish shall be brushed copper nickel to match US-25-D.

HOOK BOLT LOCK



For use with pivot-shoe roto operator in lieu of cam handles.
Standard finish shall be US-25-D clear white bronze.

88SS SUPPORT ARM

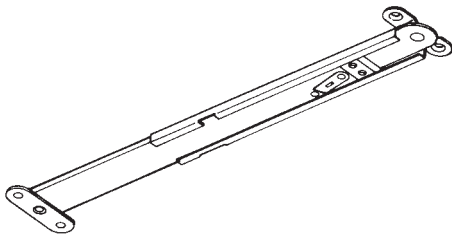

Support arms are used when window height exceeds 50-1/2".
When fully extended, the hardware automatically retains the ventilator in an open position.

**SCISSORS ARM
ROTO OPERATOR**

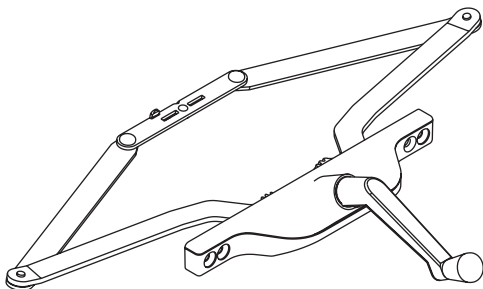

Optional scissor arm roto operator is located on the center line of the bottom horizontal frame.
Standard finish shall be brushed copper nickel to match US-25-D.

Laws and building and safety codes governing the design, and use of glazed entrance, window, and curtain wall products vary widely. Kawneer does not control the selection of product configurations, operating hardware, or glazing materials, and assumes no responsibility therefor.

Kawneer reserves the right to change configuration without prior notice when deemed necessary for product improvement.
© Kawneer Company, Inc., 2011

Laws and building and safety codes governing the design and use of glazed entrance, window, and curtain wall products vary widely. Kawneer does not control the selection of product configurations, operating hardware, or glazing materials, and assumes no responsibility therefor.

Kawneer reserves the right to change configuration without prior notice when deemed necessary for product improvement.
© Kawneer Company, Inc., 2011

Features

- Architectural Grade Window
- Non-Thermally Broken Frames
- Mitered, Clipped and Staked Vent Corner Joinery
- Screw and Spline Frame Corner Joinery
- Factory Silicone Glazed
- Interior Applied Glazing Bead with Bulb Gasket
- Architectural Anodized Finishes and Applied Coatings
- Two Year Manufacturer's Warranty
- Compatible with Storefront and Curtain Wall Systems

Laws and building and safety codes governing the design, and use of glazed entrance, window, and curtain wall products vary widely. Kawneer does not control the selection of product configurations, operating hardware, or glazing materials, and assumes no responsibility therefor.

Kawneer reserves the right to change configuration without prior notice when deemed necessary for product improvement.
© Kawneer Company, Inc., 2011

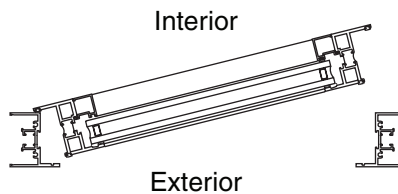
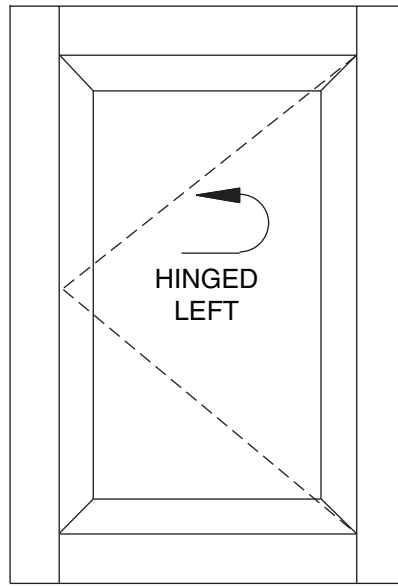

Inswing Casement Window

For specific product applications,
Consult your Kawneer representative.

CLASS and GRADE		Architectural Grade C-HC90 / C-AW90 / AW-PG90-C				
TESTING STANDARD		AAMA / WDMA / CSA 101 / I.S. 2 / A440 (NAFS)				
FRAME DEPTH		2-1/4" Overall Frame Depth				
TYPICAL WALL THICKNESS		.090 and .125 Nominal				
TYPICAL MAXIMUM SIZE		36" x 60"				
TYPICAL MINIMUM SIZE		17" x 17"				
TYPICAL CONFIGURATIONS						
STANDARD INFILL OPTIONS		1/4" and 1"				
STANDARD HARDWARE		Stainless Steel 4-Bar Hinges Cast White Bronze Cam Locks				
OPTIONAL HARDWARE		Access Control Locks Limit Stop Pole and Pole Ring Butt Hinges Keyed Limit Arm Friction Adjustor				
OTHER OPTIONS		Unequal Leg Frames Exterior and/or Interior Applied Muntins Insect Screens Perimeters and Sills Exterior Pannings and Interior Trims Structural Mullions Vertically or Horizontally Stacked Access Panels and Blinds Silicone Field Glazed upon Request				
PERFORMANCE	Air Infiltration Cfm/ft ²	Water Resistance PSF	Design Load PSF	Thermal Transmittance "U" Value	Condensation Resistance CRF	Sound Transmittance STC
	.10 @ 6.24 psf	15	90	n/a	n/a	n/a

Laws and building and safety codes governing the design and use of glazed entrance, window, and curtain wall products vary widely. Kawneer does not control the selection of product configurations, operating hardware, or glazing materials, and assumes no responsibility therefor.

Kawneer reserves the right to change configuration without prior notice when deemed necessary for product improvement.
© Kawneer Company, Inc., 2011

SCALE : 3" = 1'-0"

Laws and building and safety codes governing the design, and use of glazed entrance, window, and curtain wall products vary widely. Kawneer does not control the selection of product configurations, operating hardware, or glazing materials, and assumes no responsibility therefor.

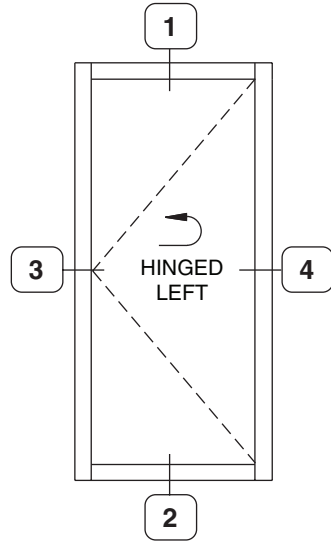

TYPICAL ELEVATION

Log onto www.kawneer.com for other configurations

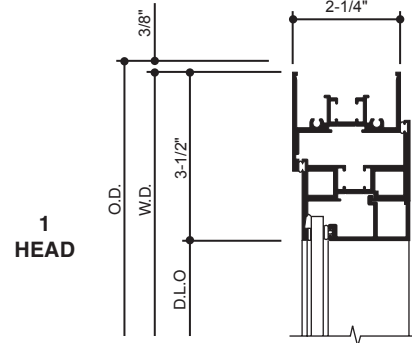

1 HEAD

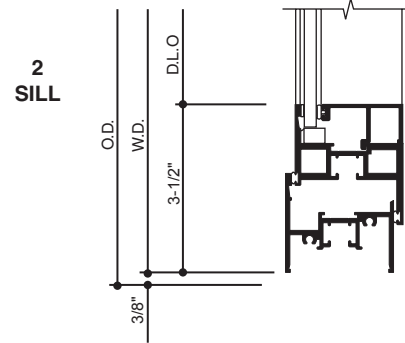

2 SILL

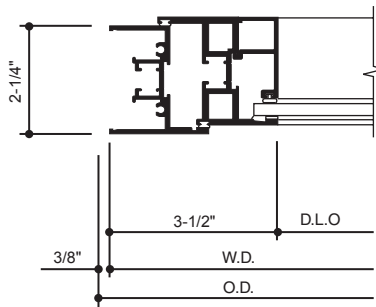

3 JAMB

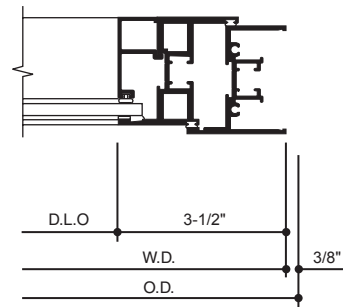

4 JAMB

Kawneer reserves the right to change configuration without prior notice when deemed necessary for product improvement.
© Kawneer Company, Inc., 2011

STAINLESS STEEL 4 BAR HINGES

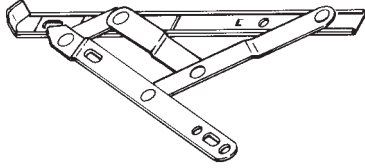

A standard hinge for ventilators providing approximately 45° to 60° openings depending on size. An optional limit stop is available to restrict hinge travel and limit vent opening.

STANDARD CAM HANDLE



Cast white bronze cam handles are standard for the manual operation and locking of ventilators.

CAM HANDLE WITH POLE RING

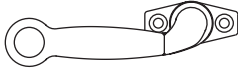

Cast white bronze cam handles with pole ring provide manual operation of ventilators located above reach. These handles are operated with a sash pole.

POLE RING



Cast white bronze pole ring is used in conjunction with locking hardware for sash pole operation of ventilators.

SASH POLE

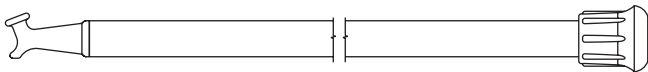

HANGER FOR SASH POLE



A 3/4" diameter aluminum sash pole with a cast white bronze pull down hook and black rubber tip. Available in 6 ft. and 12 ft. lengths with optional cast white bronze pole hanger.

ACCESS CONTROL LOCK

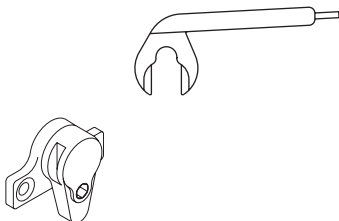

In lieu of the standard cam handles cast white bronze access control locks are offered for managed control of vent operations. Lock is operated with a manganese bronze removable handle.

Laws and building and safety codes governing the design and use of glazed entrance, window, and curtain wall products vary widely. Kawneer does not control the selection of product configurations, operating hardware, or glazing materials, and assumes no responsibility therefor.

Kawneer reserves the right to change configuration without prior notice when deemed necessary for product improvement.
© Kawneer Company, Inc., 2011

BUTT HINGES

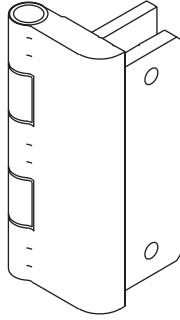

An optional hinge for ventilators providing a full 90° opening. Butt hinges shall be finished to match the window.

FRICTION ADJUSTOR

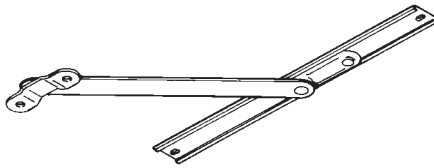

Friction adjustors shall be used with butt hinges for additional friction for control of the ventilator.

KEYED LIMIT ARM

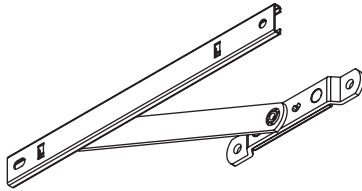

Key released limit arms may be used to restrict ventilator opening when used with butt hinges.

Laws and building and safety codes governing the design and use of glazed entrance, window, and curtain wall products vary widely. Kawneer does not control the selection of product configurations, operating hardware, or glazing materials, and assumes no responsibility therefor.

Kawneer reserves the right to change configuration without prior notice when deemed necessary for product improvement.
© Kawneer Company, Inc., 2011

Laws and building and safety codes governing the design and use of glazed entrance, window, and curtain wall products vary widely. Kawneer does not control the selection of product configurations, operating hardware, or glazing materials, and assumes no responsibility therefor.

Kawneer reserves the right to change configuration without prior notice when deemed necessary for product improvement.
© Kawneer Company, Inc., 2011

Features

- Architectural Grade Window
- Non-Thermally Broken Frames
- Mitered, Clipped and Staked Vent Corner Joinery
- Screw and Spline Frame Corner Joinery
- Factory Silicone Glazed
- Interior Applied Glazing Bead with Bulb Gasket
- Architectural Anodized Finishes and Applied Coatings
- Two Year Manufacturer's Warranty
- Compatible with Storefront and Curtain Wall Systems

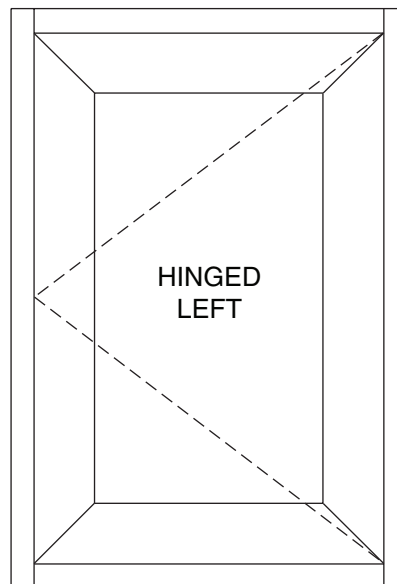

Interior

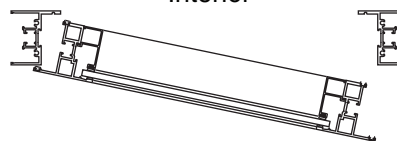

Exterior

Outswing Casement Window

For specific product applications,
Consult your Kawneer representative.

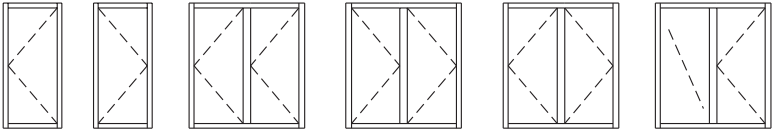
CLASS and GRADE		Architectural Grade C-HC90 / C-AW90 / AW-PG90-C				
TESTING STANDARD		AAMA / WDMA / CSA 101 / I.S. 2 / A440 (NAFS)				
FRAME DEPTH		2-1/4" Overall Frame Depth				
TYPICAL WALL THICKNESS		.090 and .125 Nominal				
TYPICAL MAXIMUM SIZE		36" x 60"				
TYPICAL MINIMUM SIZE		17" x 17"				
TYPICAL CONFIGURATIONS						
STANDARD INFILL OPTIONS		1/4" and 1"				
STANDARD HARDWARE		Stainless Steel 4-Bar Hinges Cast White Bronze Cam Locks				
OPTIONAL HARDWARE		Butt Hinges Access Control Locks Hook Bolt Lock or Multi-Point Lock Limit Stop Pole and Pole Ring Friction Adjustor Keyed Limit Arm Roto Operator				
OTHER OPTIONS		Unequal Leg Frames Exterior and/or Interior Applied Muntins Insect Screens Perimeters and Sills Exterior Pannings and Interior Trims Structural Mullions Vertically or Horizontally Stacked Access Panel and Blinds Silicone Field Glazed upon Request				
PERFORMANCE	Air Infiltration Cfm/ft ²	Water Resistance PSF	Design Load PSF	Thermal Transmittance "U" Value	Condensation Resistance CRF	Sound Transmittance STC
	.10 @ 6.24 psf	15	90	n/a	n/a	n/a

Laws and building and safety codes governing the design and use of glazed entrance, window, and curtain wall products vary widely. Kawneer does not control the selection of product configurations, operating hardware, or glazing materials, and assumes no responsibility therefor.

Kawneer reserves the right to change configuration without prior notice when deemed necessary for product improvement.
© Kawneer Company, Inc., 2011

SCALE : 3" = 1'-0"

Laws and building and safety codes governing the design, and use of glazed entrance, window, and curtain wall products vary widely. Kawneer does not control the selection of product configurations, operating hardware, or glazing materials, and assumes no responsibility therefor.

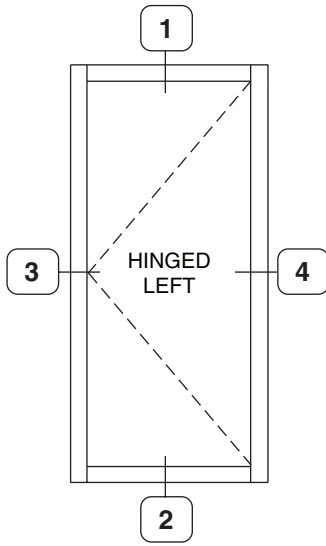

TYPICAL ELEVATION

Log onto www.kawneer.com for other configurations

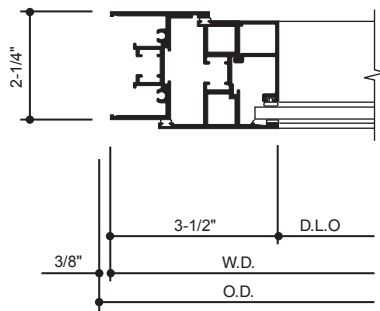
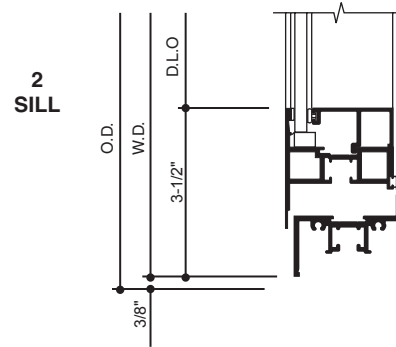
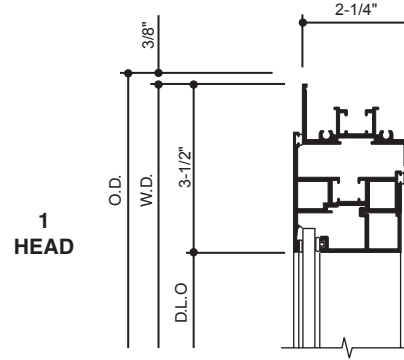

3 JAMB

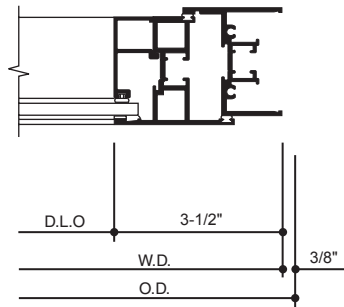

4 JAMB

Kawneer reserves the right to change configuration without prior notice when deemed necessary for product improvement.
© Kawneer Company, Inc., 2011

STAINLESS STEEL 4 BAR HINGES

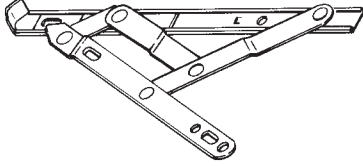

A standard hinge for ventilators providing approximately 45° to 60° openings depending on size. An optional limit stop is available to restrict hinge travel and limit vent opening.

BUTT HINGES

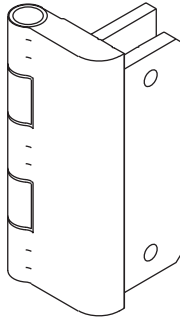

An optional hinge for ventilators providing a full 90° opening. Butt Hinges shall be finished to match the window.

FRICTION ADJUSTOR

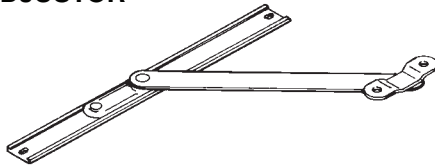

Friction adjustors shall be used with butt hinges for additional friction for control of the ventilator.

ROTO OPERATOR

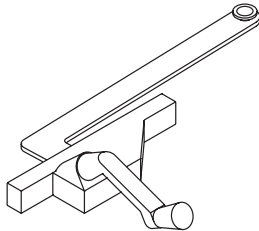

Roto operators are used with butt hinges only and located at the bottom horizontal frame. Standard finish shall be brushed copper nickel to match US-25-D.

STANDARD CAM HANDLE

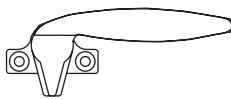

Cast white bronze cam handles are standard for the manual operation and locking of ventilators.

CAM HANDLE WITH POLE RING

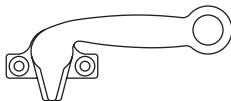

Cast white bronze cam handles with pole ring provide manual operation of ventilators located above reach. These handles are operated with a sash pole.

KEYED LIMIT ARM

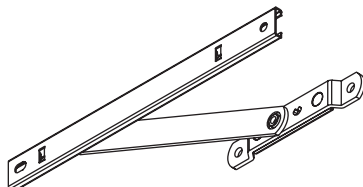

Key released limit arms may be used to restrict ventilator opening when used with butt hinges.

Laws and building and safety codes governing the design and use of glazed entrance, window, and curtain wall products vary widely. Kawneer does not control the selection of product configurations, operating hardware, or glazing materials, and assumes no responsibility therefor.

Kawneer reserves the right to change configuration without prior notice when deemed necessary for product improvement.
© Kawneer Company, Inc., 2011

POLE RING



Cast white bronze pole ring is used in conjunction with locking hardware for sash pole operation of ventilators.

SASH POLE

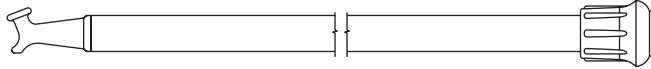

HANGER FOR SASH POLE



A 3/4" diameter aluminum sash pole with a cast white bronze pull down hook and black rubber tip. Available in 6 ft. and 12 ft. lengths with optional cast white bronze pole hanger.

ACCESS CONTROL LOCK

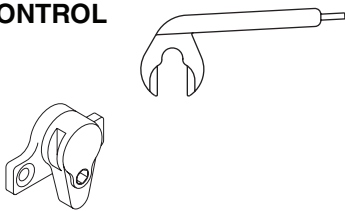

In lieu of the standard cam handles cast white bronze access control locks are offered for managed control of vent operations. Lock is operated with a manganese bronze removable handle.

HOOK BOLT LOCK



Optional hook bolt lock in lieu of cam handle. Standard finish shall be US-25-D clear white bronze.

MULTI-POINT LOCK



Optional single locking handle for concealed multi-point locks located on the vertical frame. Standard finish shall be US-25-D clear white bronze.

ESCAPE WINDOW SIGN

Vinyl escape window sign. Colors are white letters on red background.



RESCUE WINDOW SIGN

Vinyl rescue window sign with lettering on both sides. Colors are black letters on a yellow background.



Laws and building and safety codes governing the design, and use of glazed entrance, window, and curtain wall products vary widely. Kawneer does not control the selection of product configurations, operating hardware, or glazing materials, and assumes no responsibility therefor.

Kawneer reserves the right to change configuration without prior notice when deemed necessary for product improvement.
© Kawneer Company, Inc., 2011

Laws and building and safety codes governing the design and use of glazed entrance, window, and curtain wall products vary widely. Kawneer does not control the selection of product configurations, operating hardware, or glazing materials, and assumes no responsibility therefor.

Kawneer reserves the right to change configuration without prior notice when deemed necessary for product improvement.
© Kawneer Company, Inc., 2011

WIND LOAD CHARTS:

THESE CHARTS ARE BASED ON A MAXIMUM DEFLECTION OF L\175 AND/OR A MAXIMUM STRESS OF 15,152 PSI (104 MPa).

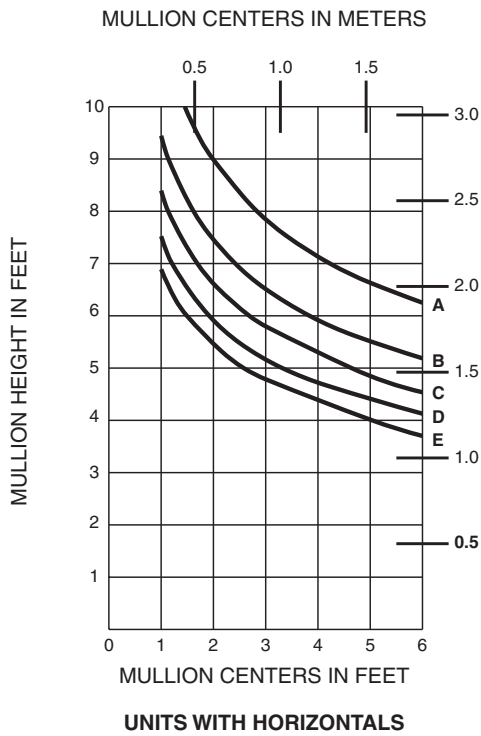

- A = 20 PSF (958)
- B = 35 PSF (1436)
- C = 50 PSF (2394)
- D = 70 PSF (3352)
- E = 90 PSF (4309)

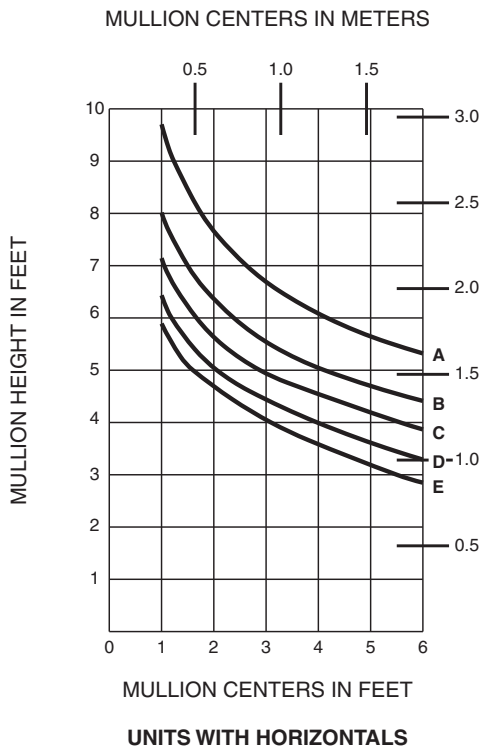
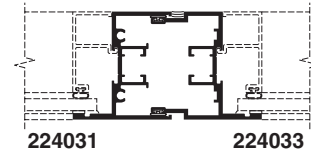

- A = 20 PSF (958)
- B = 35 PSF (1436)
- C = 50 PSF (2394)
- D = 70 PSF (3352)
- E = 90 PSF (4309)

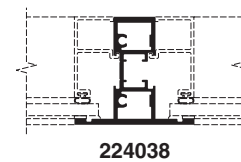

Laws and building and safety codes governing the design and use of glazed entrance, window, and curtain wall products vary widely. Kawneer does not control the selection of product configurations, operating hardware, or glazing materials, and assumes no responsibility therefor.

Kawneer reserves the right to change configuration without prior notice when deemed necessary for product improvement.
© Kawneer Company, Inc., 2011

WIND LOAD CHARTS:

THESE CHARTS ARE BASED ON A MAXIMUM DEFLECTION OF $L/175$ AND/OR A MAXIMUM STRESS OF 15,152 PSI (104 MPa).

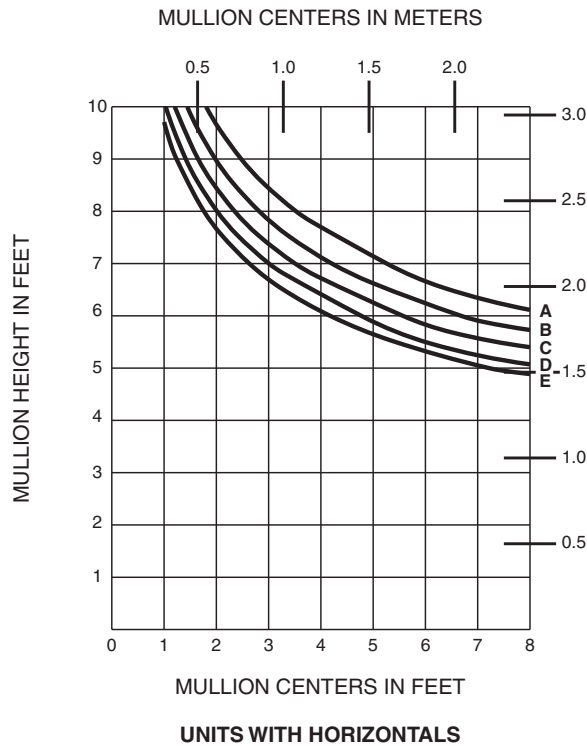

- A = 20 PSF (958)
- B = 25 PSF (1197)
- C = 30 PSF (1436)
- D = 35 PSF (1676)
- E = 40 PSF (1915)

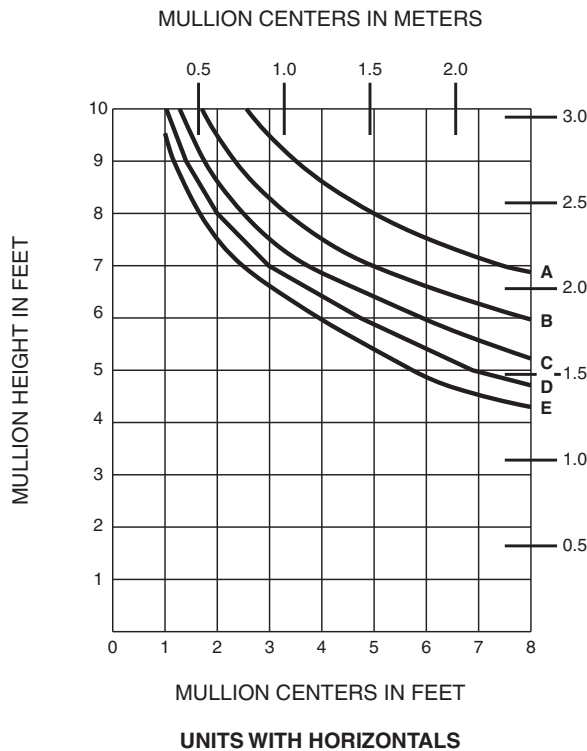
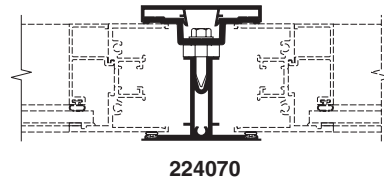

- A = 30 PSF (1436)
- B = 45 PSF (2155)
- C = 60 PSF (2873)
- D = 75 PSF (3591)
- E = 90 PSF (4309)

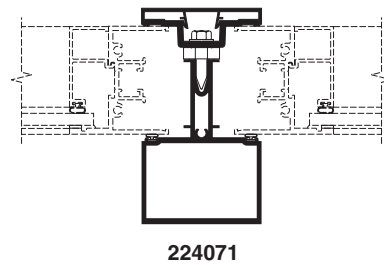

Laws and building and safety codes governing the design and use of glazed entrance, window, and curtain wall products vary widely. Kawneer does not control the selection of product configurations, operating hardware, or glazing materials, and assumes no responsibility therefor.

Kawneer reserves the right to change configuration without prior notice when deemed necessary for product improvement.
© Kawneer Company, Inc., 2011

WIND LOAD CHARTS:

THESE CHARTS ARE BASED ON A MAXIMUM DEFLECTION OF L\175 AND/OR A MAXIMUM STRESS OF 15,152 PSI (104 MPa).

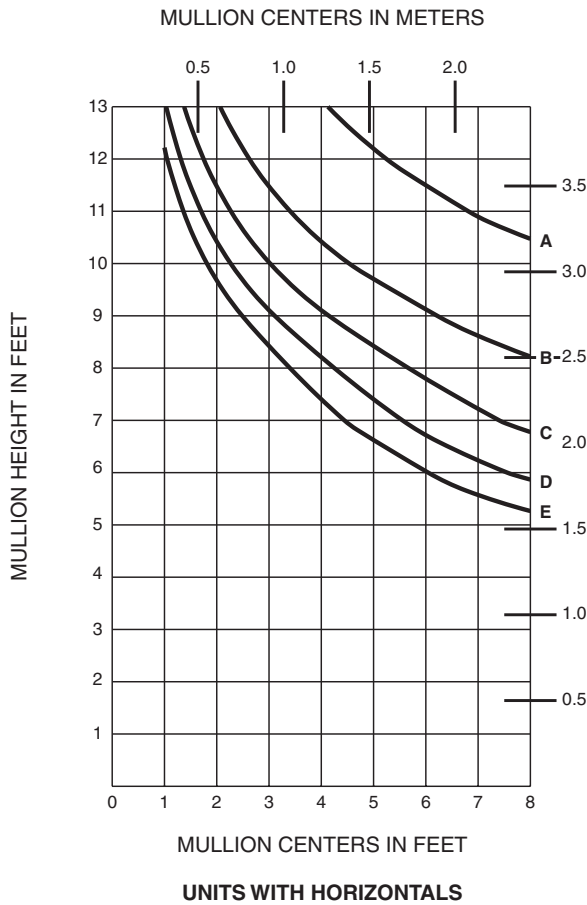

- A = 20 PSF (958)
- B = 40 PSF (1915)
- C = 60 PSF (2873)
- D = 80 PSF (3830)
- E = 100 PSF (4788)

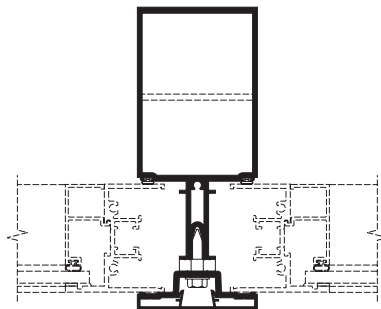
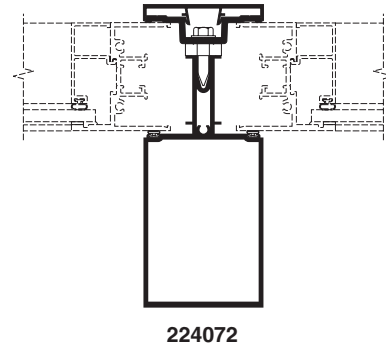

NOTE:
MULLION PROJECTION TO THE INTERIOR AVAILABLE

Laws and building and safety codes governing the design and use of glazed entrance, window, and curtain wall products vary widely. Kawneer does not control the selection of product configurations, operating hardware, or glazing materials, and assumes no responsibility therefor.

Kawneer reserves the right to change configuration without prior notice when deemed necessary for product improvement.
© Kawneer Company, Inc., 2011

SCALE : 3" = 1'-0"

EQUAL LEG SILLS

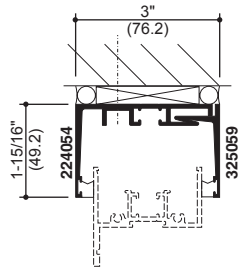

HEAD RECEPTOR

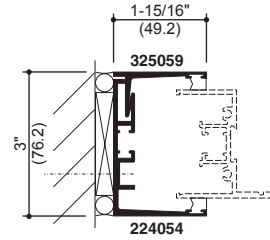

JAMB RECEPTOR

FULL DEPTH SILLS

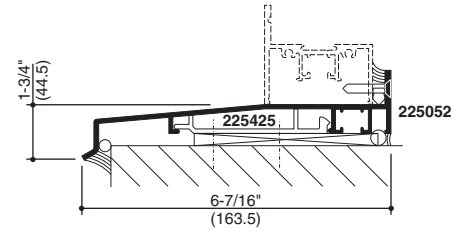
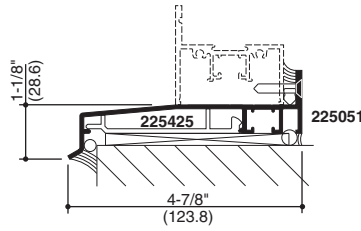
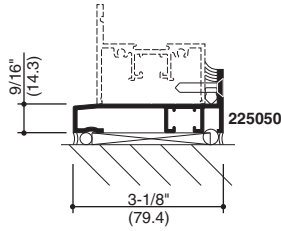

UNEQUAL LEG SILLS

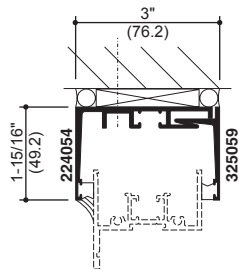

HEAD RECEPTOR

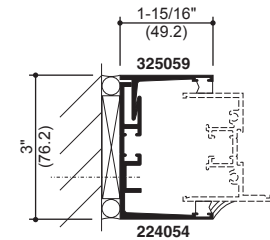

JAMB RECEPTOR

UNEQUAL LEG SILLS

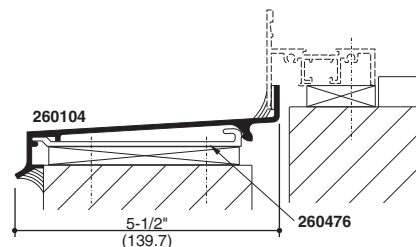
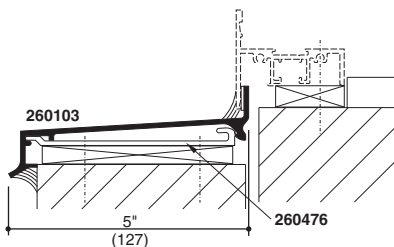
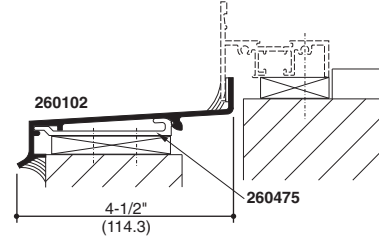
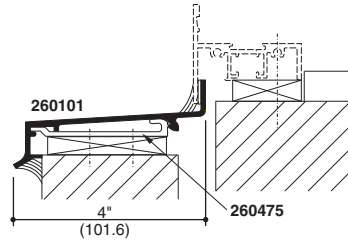
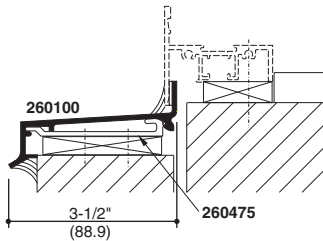

Laws and building and safety codes governing the design and use of glazed entrance, window, and curtain wall products vary widely. Kawneer does not control the selection of product configurations, operating hardware, or glazing materials, and assumes no responsibility therefor.

Kawneer reserves the right to change configuration without prior notice when deemed necessary for product improvement.
© Kawneer Company, Inc., 2011

SCALE : 3" = 1'-0"

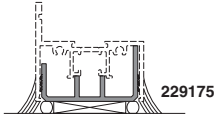

**PVC PERIMETER
(Continuous)**
Head and Jamb Similar

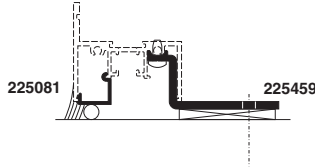

**STRAP ANCHOR
with SEALANT BACK-UP**

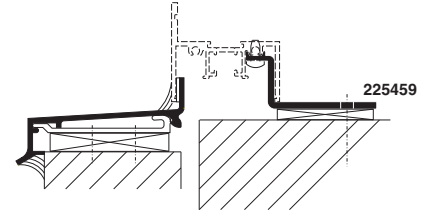

**STRAP ANCHOR
with SUB SILL**

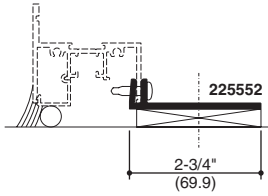

F-ANCHOR STRAP
Equal Leg Frame Only

Laws and building and safety codes governing the design and use of glazed entrance, window, and curtain wall products vary widely. Kawneer does not control the selection of product configurations, operating hardware, or glazing materials, and assumes no responsibility therefor.

Kawneer reserves the right to change configuration without prior notice when deemed necessary for product improvement.
© Kawneer Company, Inc., 2011

Laws and building and safety codes governing the design and use of glazed entrance, window, and curtain wall products vary widely. Kawneer does not control the selection of product configurations, operating hardware, or glazing materials, and assumes no responsibility therefor.

Kawneer reserves the right to change configuration without prior notice when deemed necessary for product improvement.
© Kawneer Company, Inc., 2011