

Features

- 2" (50.8) sight line
- 2-1/4" (57.2) frame depth (Veneer) and 4-1/2" (114.3) frame depth (Captured)
- Front glass plane
- Flush glazed from either the Inside or Outside (Veneer is outside glazed)
- Stick fabrication
- SSG / Weatherseal option
- 1/8" (3.2), 1/4" (6.4), or 3/8" (9.5) infill options
- Permanodic™ anodized finishes in seven choices
- Painted finishes in standard and custom choices

Product Applications

- Storefront, Ribbon window or Punched openings
- Low to Mid-rise
- Single-Span
- Integrated entrance framing allowing Kawneer standard entrances or other specialty entrances to be included

Laws and building and safety codes governing the design and use of glazed entrance, window, and curtain wall products vary widely. Kawneer does not control the selection of product configurations, operating hardware, or glazing materials, and assumes no responsibility therefor.

Kawneer reserves the right to change configuration without prior notice when deemed necessary for product improvement.
© Kawneer Company, Inc., 2010

For specific product applications,
Consult your Kawneer representative.

Laws and building and safety codes governing the design and use of glazed entrance, window, and curtain wall products vary widely. Kawneer does not control the selection of product configurations, operating hardware, or glazing materials, and assumes no responsibility therefor.

Kawneer reserves the right to change configuration without prior notice when deemed necessary for product improvement.

© Kawneer Company, Inc., 2010

Laws and building and safety codes governing the design and use of glazed entrance, window, and curtain wall products vary widely. Kawneer does not control the selection of product configurations, operating hardware, or glazing materials, and assumes no responsibility therefor.

Kawneer reserves the right to change configuration without prior notice when deemed necessary for product improvement.
© Kawneer Company, Inc., 2010

2" x 4-1/2" (50.8 x 114.3) FRAMING MEMBERS

OUTSIDE GLAZED 5

INSIDE GLAZED 6

OUTSIDE GLAZED with SSG ADAPTER 7

INSIDE GLAZED with SSG ADAPTER 8

2" x 2-1/4" (50.8 x 114.3) VENEER FRAMING MEMBERS

OUTSIDE GLAZED 9

OUTSIDE GLAZED SSG 10

CORNERS..... 11

ENTRANCE FRAMING..... 12

WIND LOAD CHARTS..... 13,15

END REACTION CHARTS 16

LAWS AND BUILDING AND SAFETY CODES GOVERNING THE DESIGN AND USE OF GLAZED ENTRANCE, WINDOW, AND CURTAIN WALL PRODUCTS VARY WIDELY. KAWNEER DOES NOT CONTROL THE SELECTION OF PRODUCT CONFIGURATIONS, OPERATING HARDWARE, OR GLAZING MATERIALS, AND ASSUMES NO RESPONSIBILITY THEREFOR.

Metric (SI) conversion figures are included throughout these details for reference. Numbers in parentheses () are millimeters unless otherwise noted.

The following metric (SI) units are found in these details:

- m – meter
- cm – centimeter
- mm – millimeter
- s – second
- Pa – pascal
- MPa – megapascal

Laws and building and safety codes governing the design and use of glazed entrance, window, and curtain wall products vary widely. Kawneer does not control the selection of product configurations, operating hardware, or glazing materials, and assumes no responsibility therefor.

Kawneer reserves the right to change configuration without prior notice when deemed necessary for product improvement.

© Kawneer Company, Inc., 2010

SCALE 3" = 1'-0"

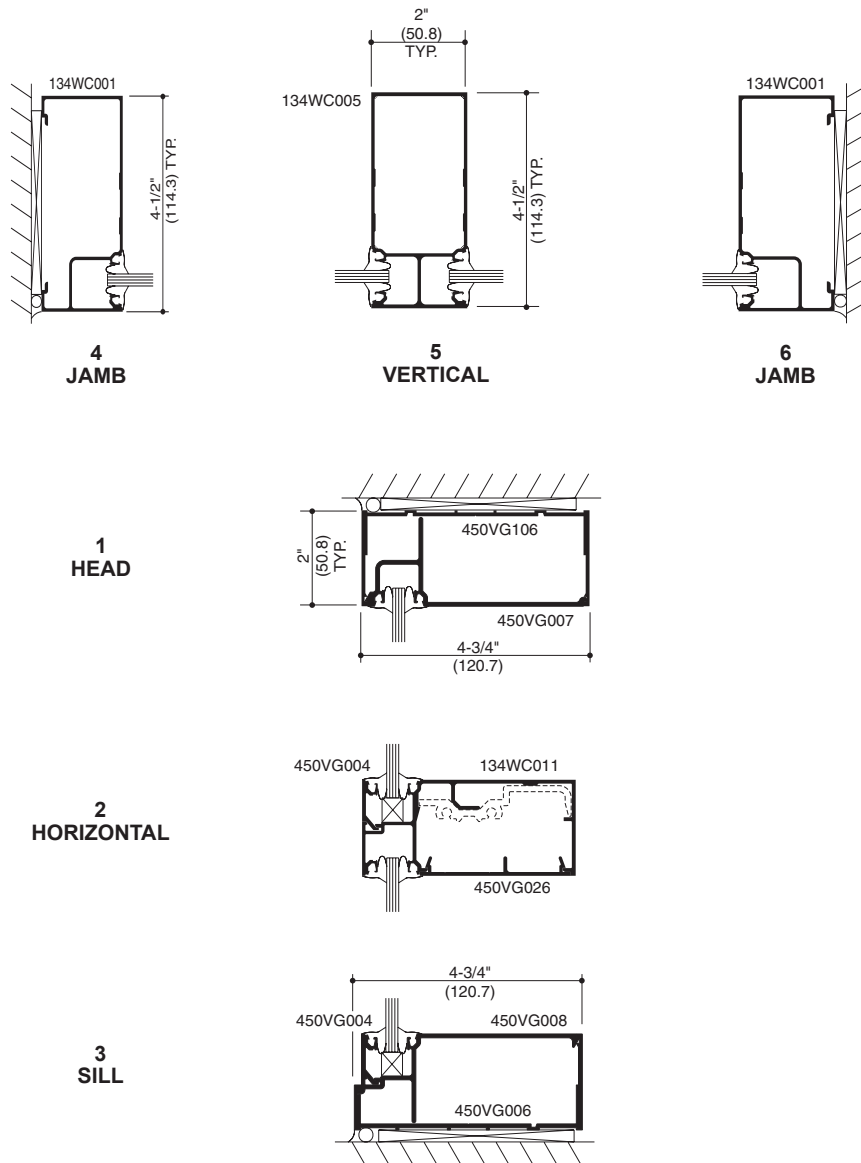
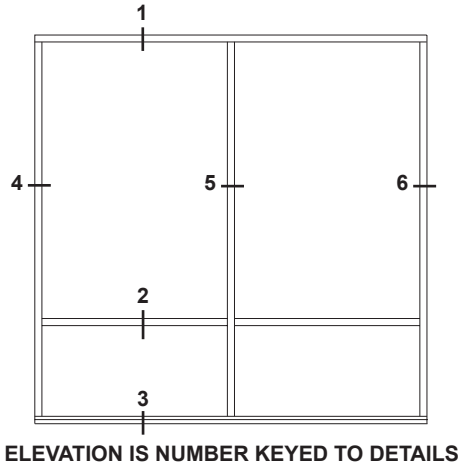

Laws and building and safety codes governing the design and use of glazed entrance, window, and curtain wall products vary widely. Kawneer does not control the selection of product configurations, operating hardware, or glazing materials, and assumes no responsibility therefor.

Kawneer reserves the right to change configuration without prior notice when deemed necessary for product improvement.
© Kawneer Company, Inc., 2010

SCALE 3" = 1'-0"

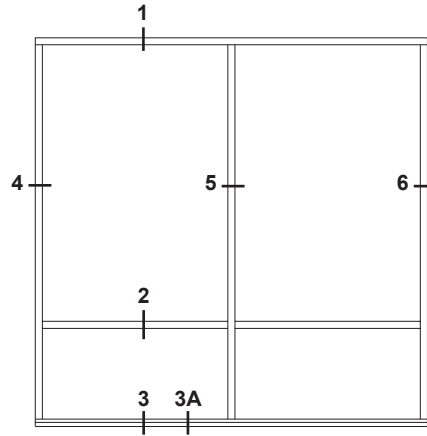

ELEVATION IS NUMBER KEYED TO DETAILS

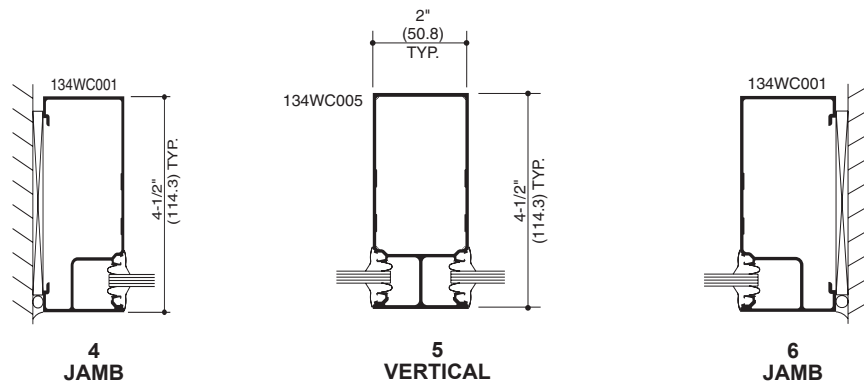

1 HEAD

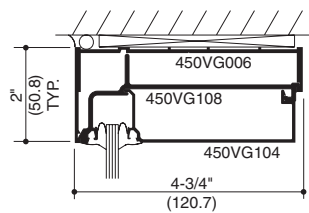

2 HORIZONTAL

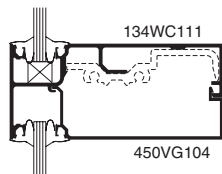

3 SILL

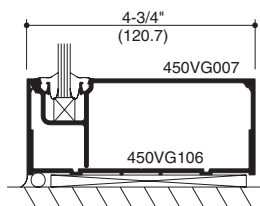

3A SILL

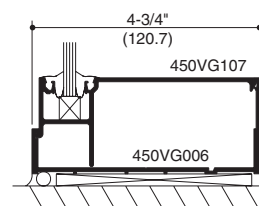

Laws and building and safety codes governing the design and use of glazed entrance, window, and curtain wall products vary widely. Kawneer does not control the selection of product configurations, operating hardware, or glazing materials, and assumes no responsibility therefor.

Kawneer reserves the right to change configuration without prior notice when deemed necessary for product improvement.

© Kawneer Company, Inc., 2010

SCALE 3" = 1'-0"

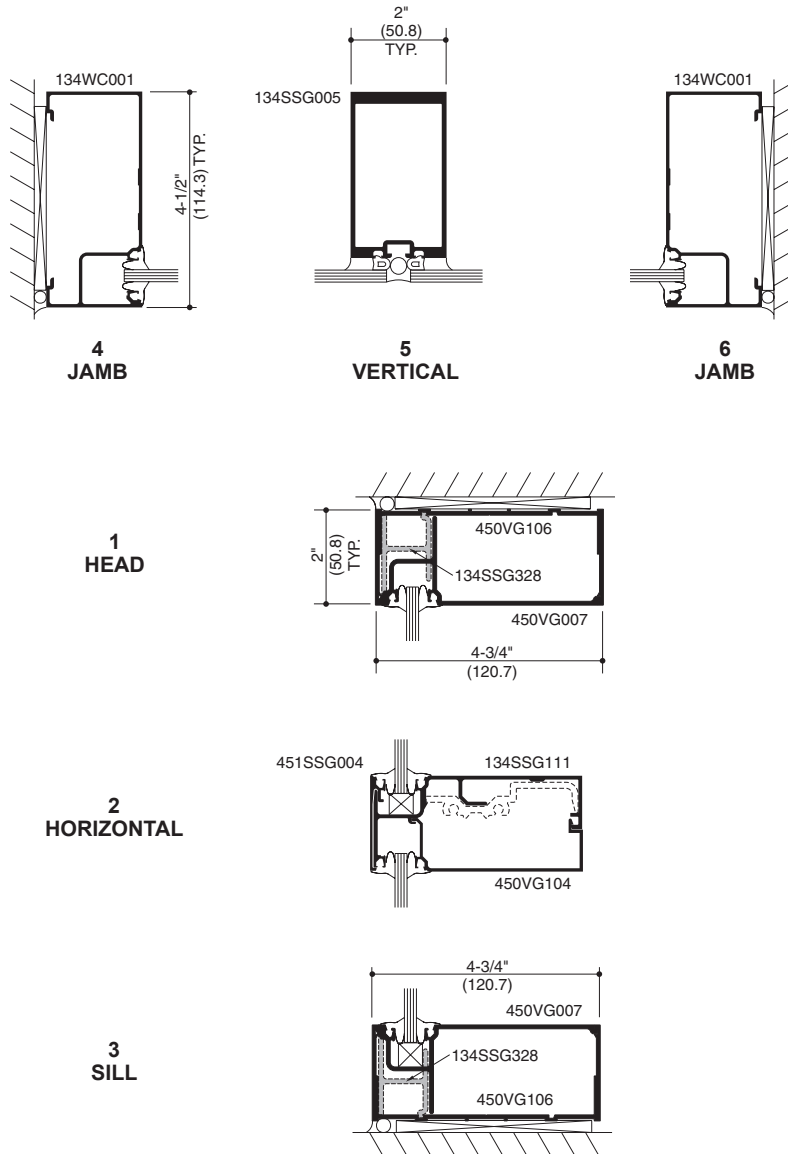
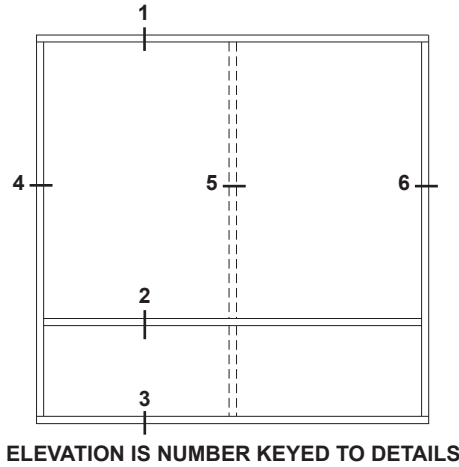

Laws and building and safety codes governing the design and use of glazed entrance, window, and curtain wall products vary widely. Kawneer does not control the selection of product configurations, operating hardware, or glazing materials, and assumes no responsibility therefor.

Kawneer reserves the right to change configuration without prior notice when deemed necessary for product improvement.
© Kawneer Company, Inc., 2010

SCALE 3" = 1'-0"

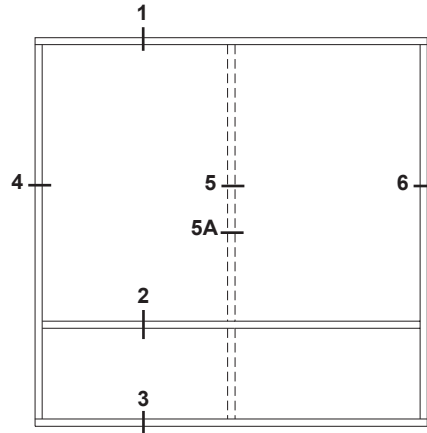

ELEVATION IS NUMBER KEYED TO DETAILS

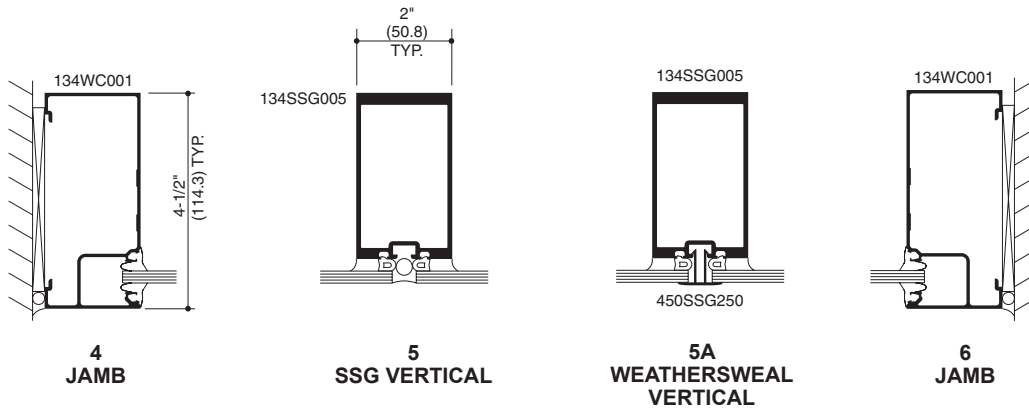

1 HEAD

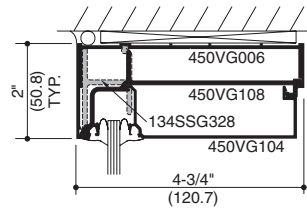

2 HORIZONTAL

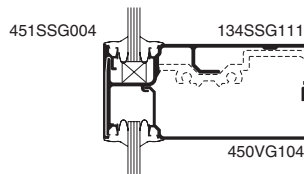

3 SILL

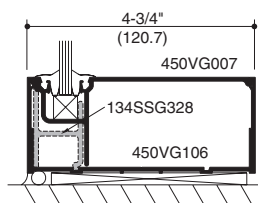

Laws and building and safety codes governing the design and use of glazed entrance, window, and curtain wall products vary widely. Kawneer does not control the selection of product configurations, operating hardware, or glazing materials, and assumes no responsibility therefor.

Kawneer reserves the right to change configuration without prior notice when deemed necessary for product improvement.
© Kawneer Company, Inc., 2010

SCALE 3" = 1'-0"

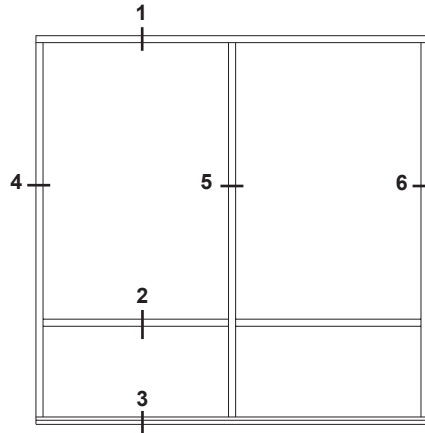

ELEVATION IS NUMBER KEYED TO DETAILS

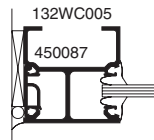

**4
JAMB**

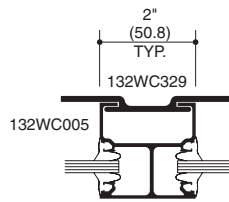

**5
VERTICAL**

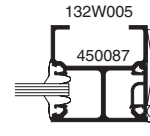

**6
JAMB**

**1
HEAD**

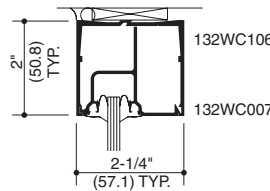

**2
HORIZONTAL**

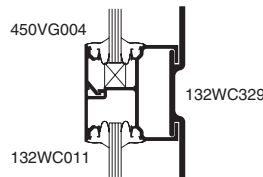

**3
SILL**

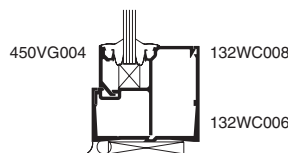

Laws and building and safety codes governing the design and use of glazed entrance, window, and curtain wall products vary widely. Kawneer does not control the selection of product configurations, operating hardware, or glazing materials, and assumes no responsibility therefor.

Kawneer reserves the right to change configuration without prior notice when deemed necessary for product improvement.
© Kawneer Company, Inc., 2010

SCALE 3" = 1'-0"

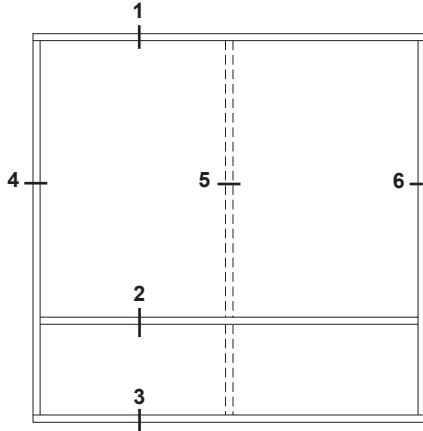

ELEVATION IS NUMBER KEYED TO DETAILS

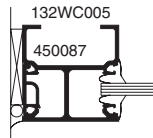

4
JAMB

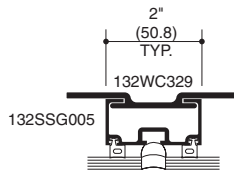

5
VERTICAL

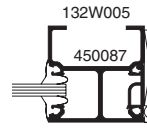

6
JAMB

1
HEAD

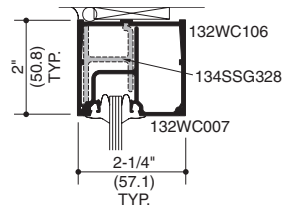

2
HORIZONTAL

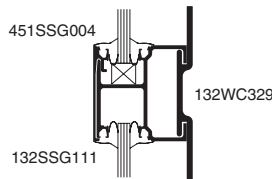

3
SILL

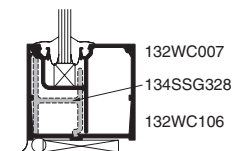

Laws and building and safety codes governing the design and use of glazed entrance, window, and curtain wall products vary widely. Kawneer does not control the selection of product configurations, operating hardware, or glazing materials, and assumes no responsibility therefor.

Kawneer reserves the right to change configuration without prior notice when deemed necessary for product improvement.

© Kawneer Company, Inc., 2010

SCALE 3" = 1'-0"

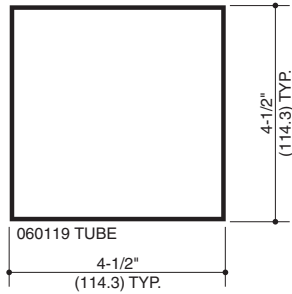

4-1/2" x 4-1/2" (114.3 x 114.3) TUBE

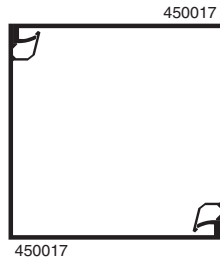

TWO PIECE NO POCKET CORNER

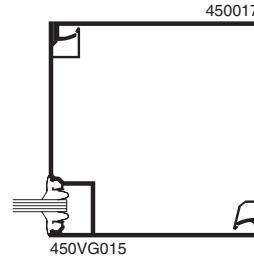

ONE POCKET CORNER

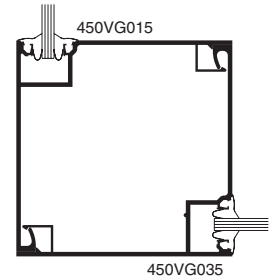

TWO POCKET 90° CORNER

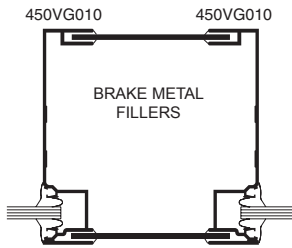

TWO POCKET BRAKE METAL POST

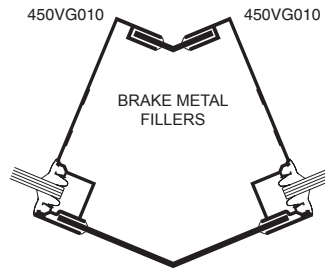

VARIABLE DEGREE BRAKE METAL OUTSIDE CORNER

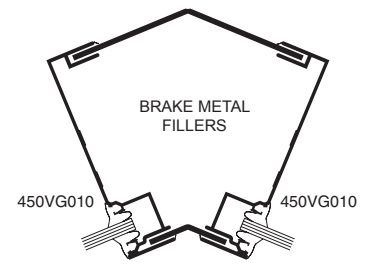

VARIABLE DEGREE BRAKE METAL INSIDE CORNER

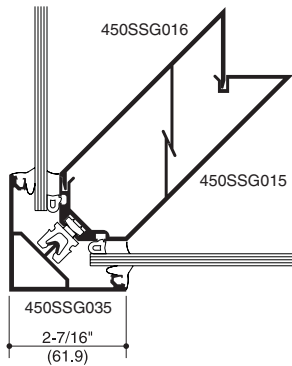

90° CORNER

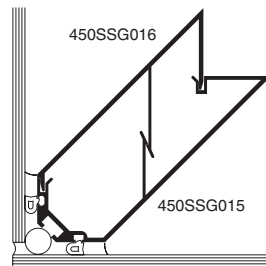

90° SSG CORNER

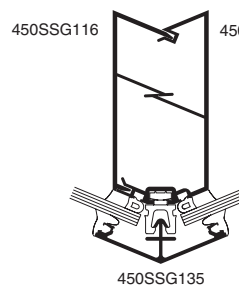

135° CORNER

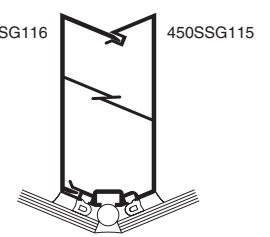

135° SSG CORNER

Laws and building and safety codes governing the design and use of glazed entrance, window, and curtain wall products vary widely. Kawneer does not control the selection of product configurations, operating hardware, or glazing materials, and assumes no responsibility therefor.

Kawneer reserves the right to change configuration without prior notice when deemed necessary for product improvement.
© Kawneer Company, Inc., 2010

SCALE 3" = 1'-0"

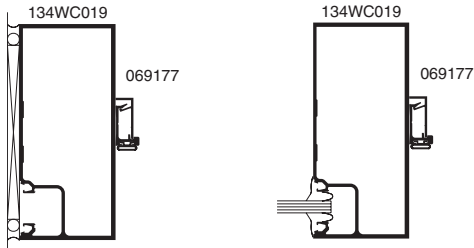

**SINGLE ACTING
DOOR JAMBS**

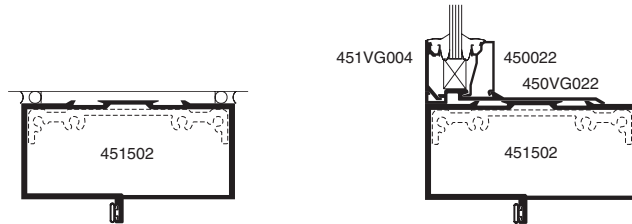

FOR SURFACE CLOSER

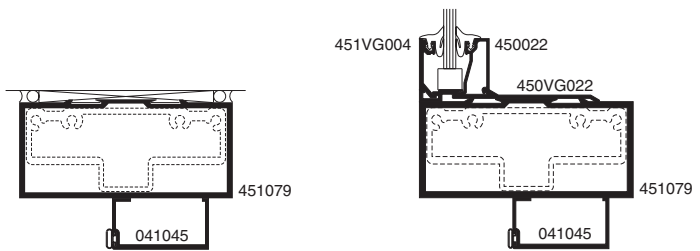

FOR SAM-II COC CLOSER

**SINGLE ACTING
HEADER / TRANSOM BAR**

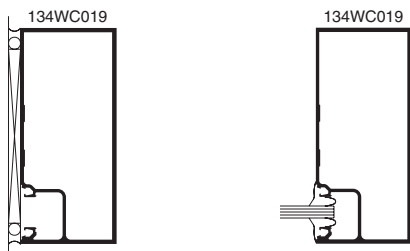

**DOUBLE ACTING
DOOR JAMBS**

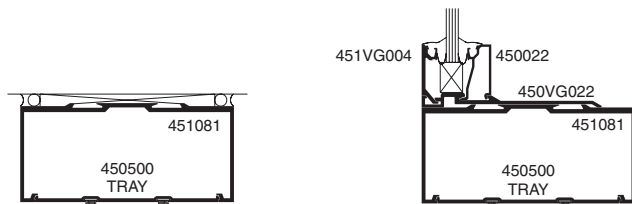

FOR CONCEALED CLOSER

**DOUBLE ACTING
HEADER / TRANSOM BAR**

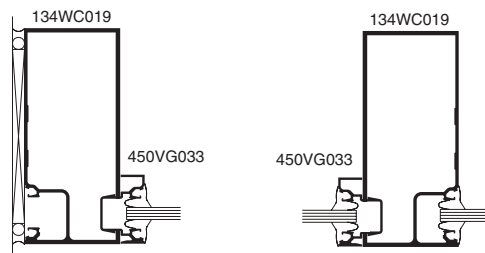

TRANSOM AREA

Transom area for both double and single acting doors with glass surround. Jambs above transom bar are routed out to accept glass holding Insert (450VG033).

Local building and safety codes governing the design and use of glazed entrance, window, and curtain wall products vary widely. Kawneer does not control the selection of product configurations, operating hardware, or glazing materials, and assumes no responsibility therefor.

Kawneer reserves the right to change configuration without prior notice when deemed necessary for product improvement.
© Kawneer Company, Inc., 2010

WIND LOAD CHARTS

Mullions are designed for deflection limitations in accordance with AAMA TIR-A11 of L/175 up to 13'-6" and L/240 +1/4" above 13'-6". These curves are for mullions WITH HORIZONTALS and are based on engineering calculations for stress and deflection. Allowable wind load stress for ALUMINUM 15,152 psi (104MPa), STEEL 30,000 psi (207MPa). Charted curves, in all cases are for the limiting value. Wind load charts contained herein are based upon nominal wind load utilized in allowable stress design. A conversion from Load Resistance Factor Design (LRFD) is provided. To convert ultimate wind loads to nominal loads, multiply ultimate wind loads by a factor of 0.6 per ASCE/SEI 7. A 4/3 increase in allowable stress has not been used to develop these curves. For special situations not covered by these curves, contact your Kawneer representative for additional information.

If the end reaction of the mullion [mullion spacing (ft.) times height (ft.) times specified wind load (psf) divided by two] is more than 500 lbs., the optional Mullion Anchors must be used. Consult Application Engineering. (*Mullion Anchor not used with Lightweight Receptor.*)

Laws and building and safety codes governing the design and use of glazed entrance, window, and curtain wall products vary widely. Kawneer does not control the selection of product configurations, operating hardware, or glazing materials, and assumes no responsibility therefor.

Kawneer reserves the right to change configuration without prior notice when deemed necessary for product improvement.
© Kawneer Company, Inc., 2010

	Allowable Stress Design Load	LRFD Ultimate Design Load
A =	15 PSF (720)	25 PSF (1200)
B =	20 PSF (960)	33 PSF (1580)
C =	25 PSF (1200)	42 PSF (2000)
D =	30 PSF (1440)	50 PSF (2400)
E =	40 PSF (1920)	67 PSF (3200)

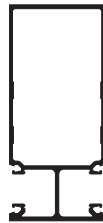
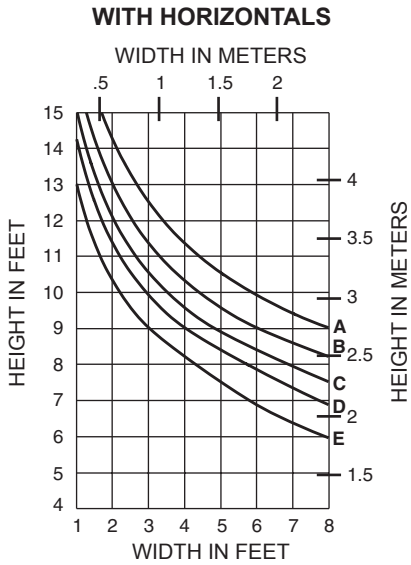

134WC005

$I = 2.892 (120.37 \times 10^4)$
 $S = 1.125 (18.44 \times 10^3)$

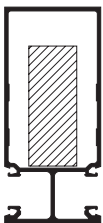
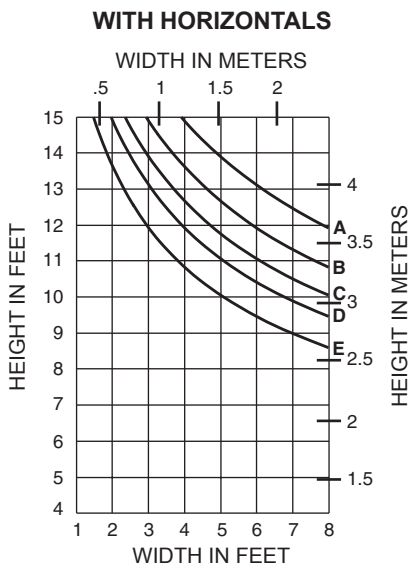
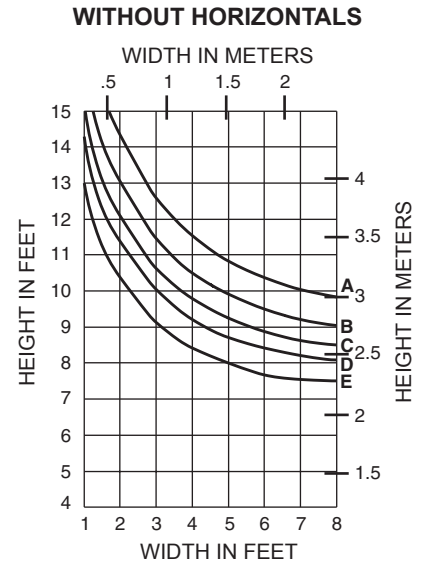

134WC005

$I_A = 2.892 (120.37 \times 10^4)$
 $S_A = 1.125 (18.44 \times 10^3)$
1" x 2-1/2" (25.4 x 63.5) STEEL BAR
 $I_s = 1.302 (54.19 \times 10^4)$
 $S_s = 1.042 (17.08 \times 10^3)$

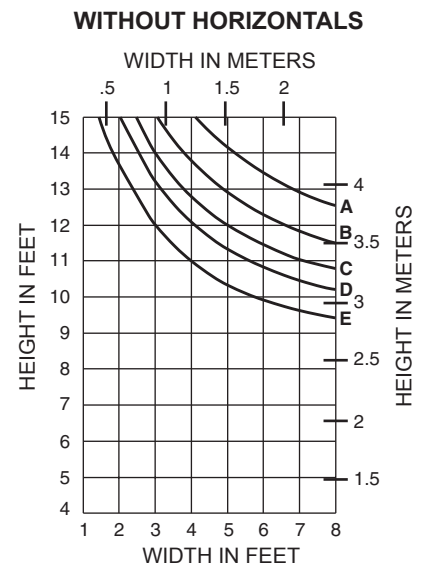

Laws and building and safety codes governing the design and use of glazed entrance, window, and curtain wall products vary widely. Kawneer does not control the selection of product configurations, operating hardware, or glazing materials, and assumes no responsibility therefor.

Kawneer reserves the right to change configuration without prior notice when deemed necessary for product improvement.
© Kawneer Company, Inc., 2010

	Allowable Stress Design Load	LRFD Ultimate Design Load
A =	15 PSF (720)	25 PSF (1200)
B =	20 PSF (960)	33 PSF (1580)
C =	25 PSF (1200)	42 PSF (2000)
D =	30 PSF (1440)	50 PSF (2400)
E =	40 PSF (1920)	67 PSF (3200)

Laws and building and safety codes governing the design and use of glazed entrance, window, and curtain wall products vary widely. Kawneer does not control the selection of product configurations, operating hardware, or glazing materials, and assumes no responsibility therefor.

Kawneer reserves the right to change configuration without prior notice when deemed necessary for product improvement.
© Kawneer Company, Inc., 2010

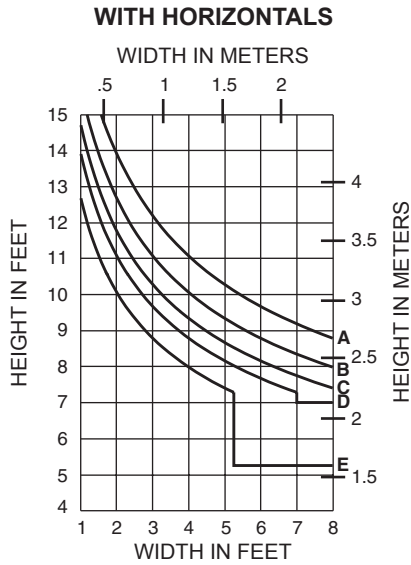

134SSG005

$I_A = 2.672 (111.22 \times 10^4)$
 $S_A = 1.437 (23.55 \times 10^3)$

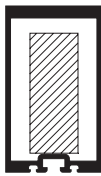
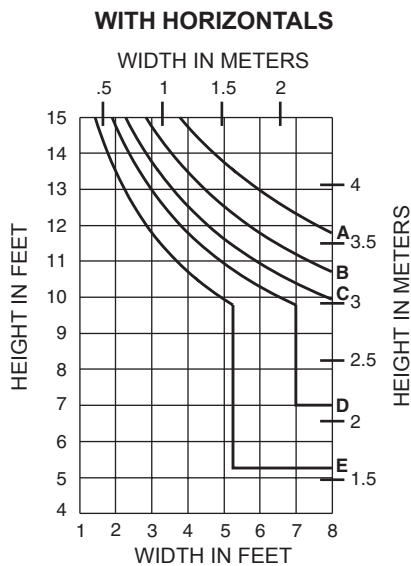
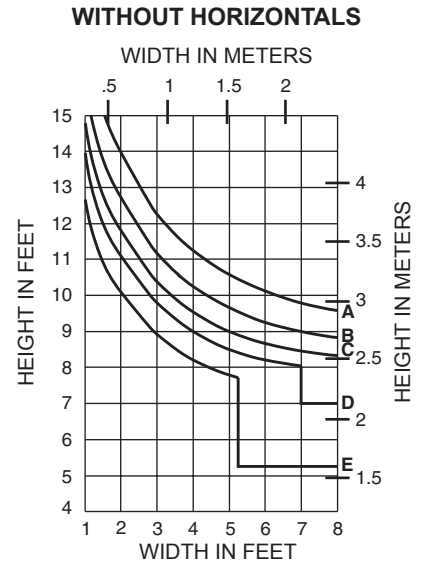

134SSG005

$I_A = 2.672 (111.22 \times 10^4)$
 $S_A = 1.437 (23.55 \times 10^3)$

1" x 2-1/2" (25.4 x 63.5) STEEL BAR

$I_s = 1.302 (54.19 \times 10^4)$
 $S_s = 1.042 (17.08 \times 10^3)$

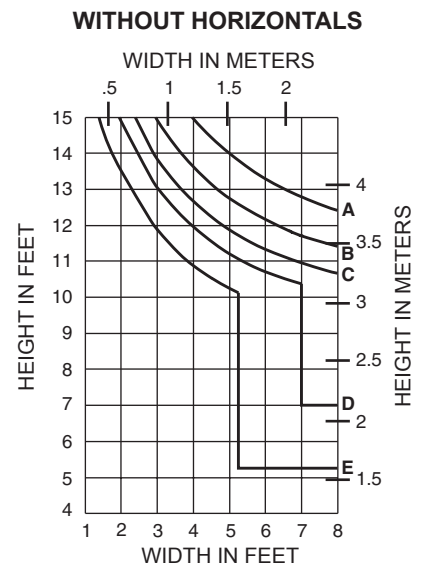

For each application, end reactions MUST be checked. These charts are used to verify that the end reactions at the head and sill receptors are 500 lbs. (2224N) or less and will meet the specified wind load.

	Allowable Stress Design Load	LRFD Ultimate Design Load
A =	15 PSF (720)	25 PSF (1200)
B =	20 PSF (960)	33 PSF (1580)
C =	25 PSF (1200)	42 PSF (2000)
D =	30 PSF (1440)	50 PSF (2400)
E =	40 PSF (1920)	67 PSF (3200)

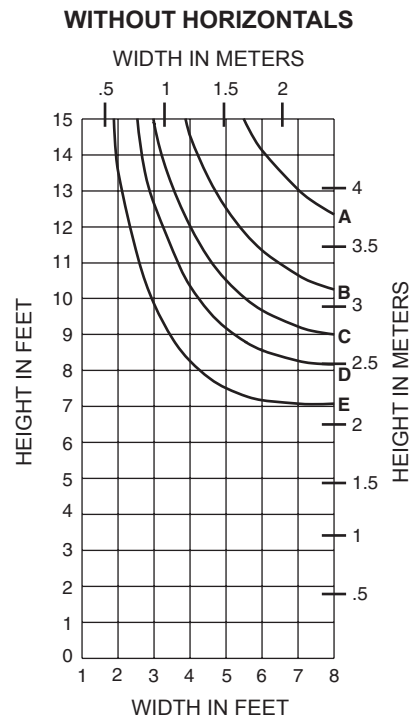
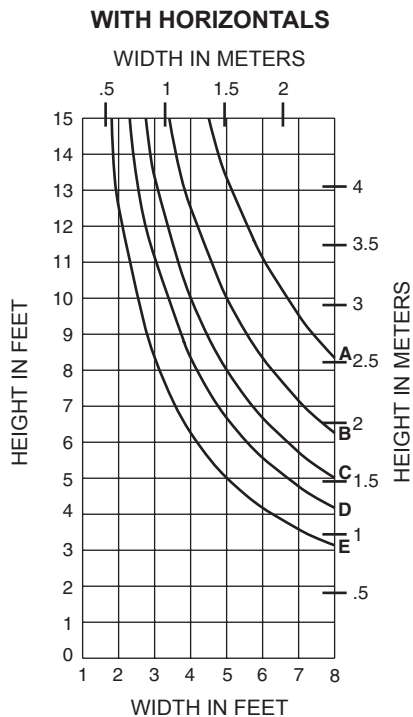

500lbs. Max. End Reaction

Laws and building and safety codes governing the design and use of glazed entrance, window, and curtain wall products vary widely. Kawneer does not control the selection of product configurations, operating hardware, or glazing materials, and assumes no responsibility therefor.

Kawneer reserves the right to change configuration without prior notice when deemed necessary for product improvement.
© Kawneer Company, Inc., 2010