

SAFETY RAILS2

APPLIED GLASS STOPS3

TUBES4

STOOL TRIM AND ACCESSORIES.....5

Laws and building and safety codes governing the design and use of Kawneer products, such as glazed entrance, window, and curtain wall products, vary widely. Kawneer does not control the selection of product configurations, operating hardware, or glazing materials, and assumes no responsibility therefor.

Kawneer reserves the right to change configuration without prior notice when deemed necessary for product improvement.
© 2014, Kawneer Company, Inc.

Metric (SI) conversion figures are included throughout these details for reference. Numbers in parentheses () are millimeters unless otherwise noted.

The following metric (SI) units are found in these details:

- m – meter
- cm – centimeter
- mm – millimeter
- s – second
- Pa – pascal
- MPa – megapascal

For specific product applications,
consult your Kawneer representative.

Additional information and CAD details are available at www.kawneer.com



RAILING MOUNTED ON FACE OF MULLION



RAILING MOUNTED BETWEEN MULLIONS

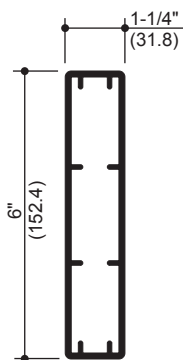

104060 SAFETY RAIL



060274 STAND OFF ANCHOR BAR



060275 STANDARD END CAP

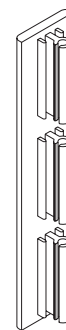

060276 BETWEEN MULLION END CAP

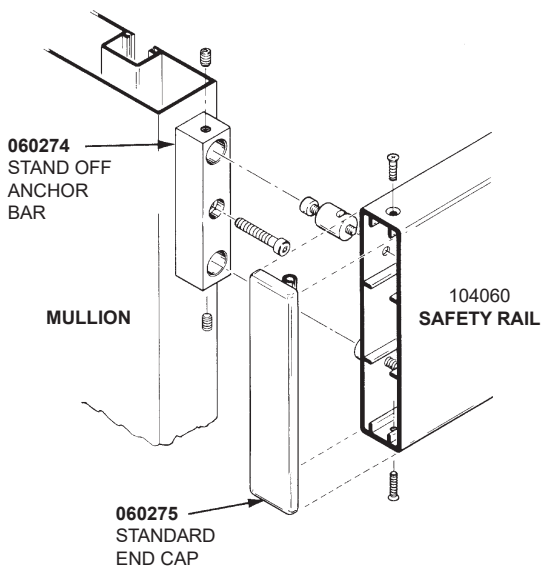

RAILING MOUNTED ON FACE OF MULLION

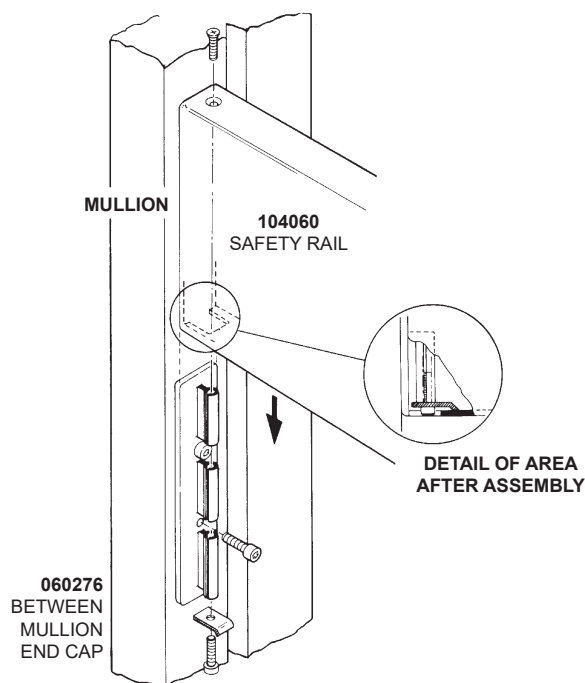

RAILING MOUNTED BETWEEN MULLIONS

Laws and building and safety codes governing the design and use of Kawneer products, such as glazed entrance, window, and curtain wall products, vary widely. Kawneer does not control the selection of product configurations, operating hardware, or glazing materials, and assumes no responsibility therefor.

Kawneer reserves the right to change configuration without prior notice when deemed necessary for product improvement.
© 2014, Kawneer Company, Inc.

Additional information and CAD details are available at www.kawneer.com

GLASS STOP ASSEMBLIES

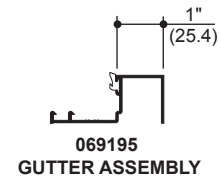
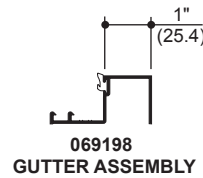
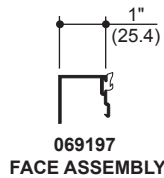
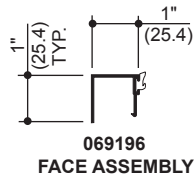

ASSEMBLY COMBINATIONS

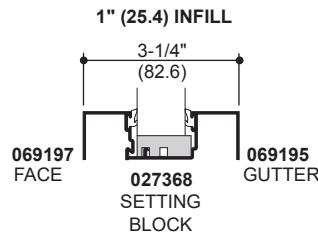
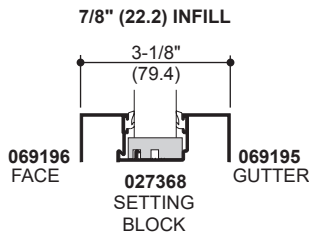
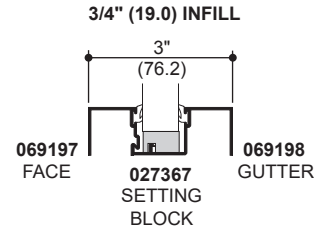
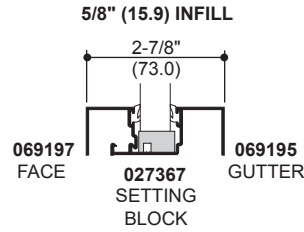
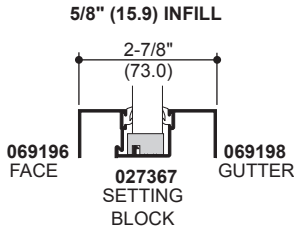
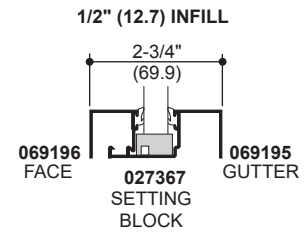
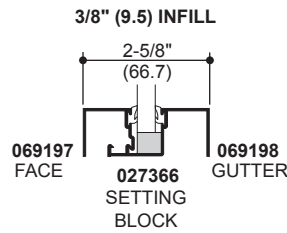
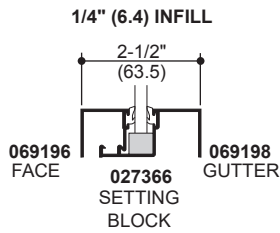

TYPICAL APPLICATION

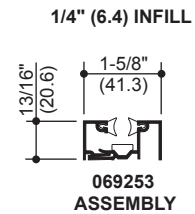
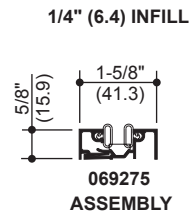
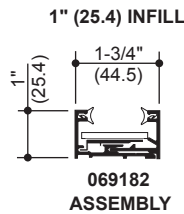
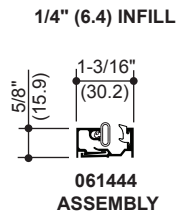
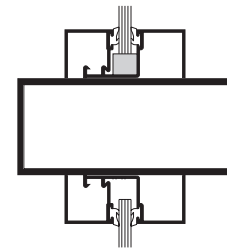

PIERCED STOPS

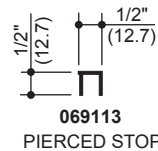
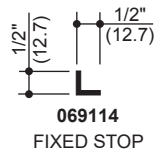
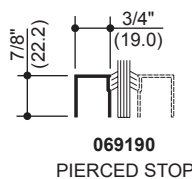

TYPICAL APPLICATION

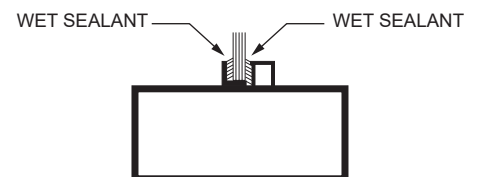

Laws and building and safety codes governing the design and use of Kawneer products, such as glazed entrance, window, and curtain wall products, vary widely. Kawneer does not control the selection of product configurations, operating hardware, or glazing materials, and assumes no responsibility therefor.

Kawneer reserves the right to change configuration without prior notice when deemed necessary for product improvement.
© 2014, Kawneer Company, Inc.

Additional information and CAD details are available at www.kawneer.com

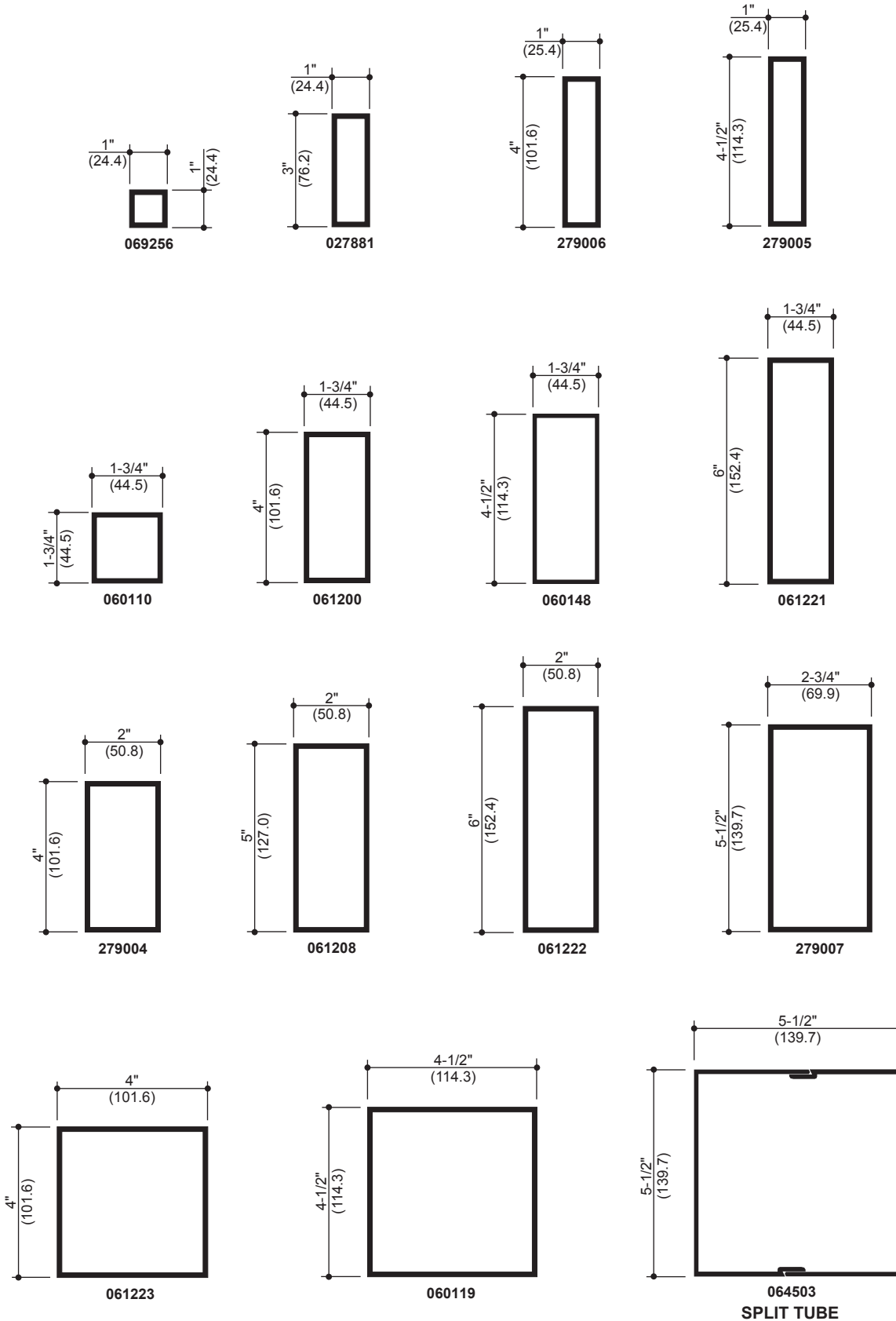

Laws and building and safety codes governing the design and use of Kawneer products, such as glazed entrance, window, and curtain wall products, vary widely. Kawneer does not control the selection of product configurations, operating hardware, or glazing materials, and assumes no responsibility therefor.

Kawneer reserves the right to change configuration without prior notice when deemed necessary for product improvement.

© 2014, Kawneer Company, Inc.

Additional information and CAD details are available at www.kawneer.com

STOOL TRIMS

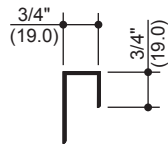

069263
GYPSUM BOARD TRIM

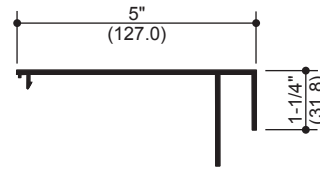

069266
5" STOOL TRIM

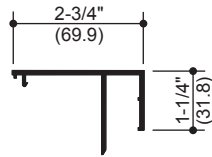

069264
2-3/4" STOOL TRIM

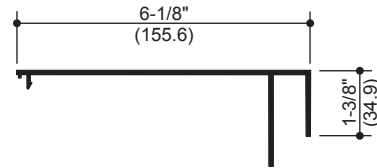

069267
6-1/8" STOOL TRIM

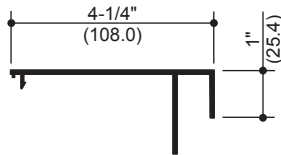

069265
4-1/4" STOOL TRIM

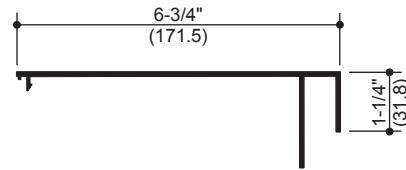

069268
6-3/4" STOOL TRIM

STOOL TRIM CLIPS

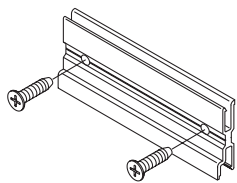

450VG640
4" REVERSABLE
STOOL TRIM CLIP PACKAGE
(TRIFAB VG 450)

For use with both Standard and HP Flashing



450VG140
(STOCK LENGTH)

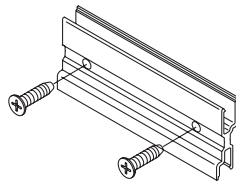

451VG640
4" REVERSABLE
STOOL TRIM CLIP PACKAGE
(TRIFAB VG 451/451T)

For use with both Standard and HP Flashing



451VG140
(STOCK LENGTH)

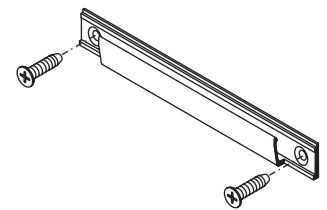

069271
STOOL TRIM CLIP PACKAGE

NOTE:
Not compatible with all sill configurations

APPLIED DOOR STOPS

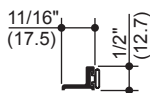

069154

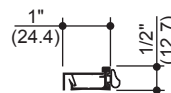

069177

Laws and building and safety codes governing the design and use of Kawneer products, such as glazed entrance, window, and curtain wall products, vary widely. Kawneer does not control the selection of product configurations, operating hardware, or glazing materials, and assumes no responsibility therefor.

Kawneer reserves the right to change configuration without prior notice when deemed necessary for product improvement.
© 2014, Kawneer Company, Inc.

Laws and building and safety codes governing the design and use of Kawneer products, such as glazed entrance, window, and curtain wall products, vary widely. Kawneer does not control the selection of product configurations, operating hardware, or glazing materials, and assumes no responsibility therefor.

Kawneer reserves the right to change configuration without prior notice when deemed necessary for product improvement.
© 2014, Kawneer Company, Inc.